



AT2020USB-XP

Cardioid Condenser USB Microphone

User Manual

Safety precautions

Although this product was designed to be used safely, failing to use it correctly may result in an accident. To ensure safety, observe all warnings and cautions while using the product.

Cautions for the product

- Do not subject the product to strong impact to avoid malfunction.
- Do not disassemble, modify or attempt to repair the product.
- Do not handle the product with wet hands to avoid electric shock or injury.
- Do not store the product under direct sunlight, near heating devices or in a hot, humid or dusty place.

For customers in the USA

FCC Notice

Warning

This device complies with Part 15 of the FCC Rules. Operation is subject to the following two conditions: (1) This device may not cause harmful interference, and (2) this device must accept any interference received, including interference that may cause undesired operation.

Caution

You are cautioned that any changes or modifications not expressly approved in this manual could void your authority to operate this equipment.

Note: This equipment has been tested and found to comply with the limits for a Class B digital device, pursuant to part 15 of the FCC Rules. These limits are designed to provide reasonable protection against harmful interference in a residential installation. This equipment generates, uses and can radiate radio frequency energy and, if not installed and used in accordance with the instructions, may cause harmful interference to radio communications. However, there is no guarantee that interference will not occur in a particular installation. If this equipment does cause harmful interference to radio or television reception, which can be determined by turning the equipment off and on, the user is encouraged to try to correct the interference by one or more of the following measures:

- Reorient or relocate the receiving antenna.
- Increase the separation between the equipment and receiver.
- Connect the equipment into an outlet on a circuit different from that to which the receiver is connected.
- Consult the dealer or an experienced radio/TV technician for help.

Contact

Responsible Company: Audio-Technica U.S., Inc.
Address: 1221 Commerce Drive, Stow, Ohio 44224, USA
Tel: 330-686-2600

For customers in Canada

ISED statement

CAN ICES-3(B)/NMB-3(B)

Notes on use

- Be sure to read the connected device's user manual before use.
- When the product is used for a long time, the product may become discolored due to ultraviolet light (especially direct sunlight) and wear.
- Use the included USB cable for connection.
- Make sure to hold the plug when connecting and disconnecting the USB cable. The USB cable may become severed or an accident may occur if you pull on the USB cable itself.
- When using the USB cable, be careful not to twist it to prevent damage to the USB cable.
- Do not wind the USB cable at the base of the plug to prevent a disconnection.
- Do not use a USB hub or USB extension cable.
- When plugging the USB cable into the microphone and the connected device, check that the connector is facing in the correct direction before inserting it straight. Inserting the plug diagonally may cause a malfunction.
- When not in use, disconnect the USB cable from the product.
- Make sure that no foreign matter enters inside the mesh part of the product. Performance may be degraded.
- Depending on the surface treatment of the table on which the product is installed, the desk stand may leave marks on the table.
- For important recordings, perform a trial recording beforehand to make sure that the sound is recorded correctly.
- Operation is not guaranteed with all computers.
- Operation cannot be guaranteed in a home-built computer, personal OS upgrade, or multi-boot environment.
- Audio-Technica will not be liable in any way for any loss or damage to software or data connected to the product.

Part names and functions

Microphone

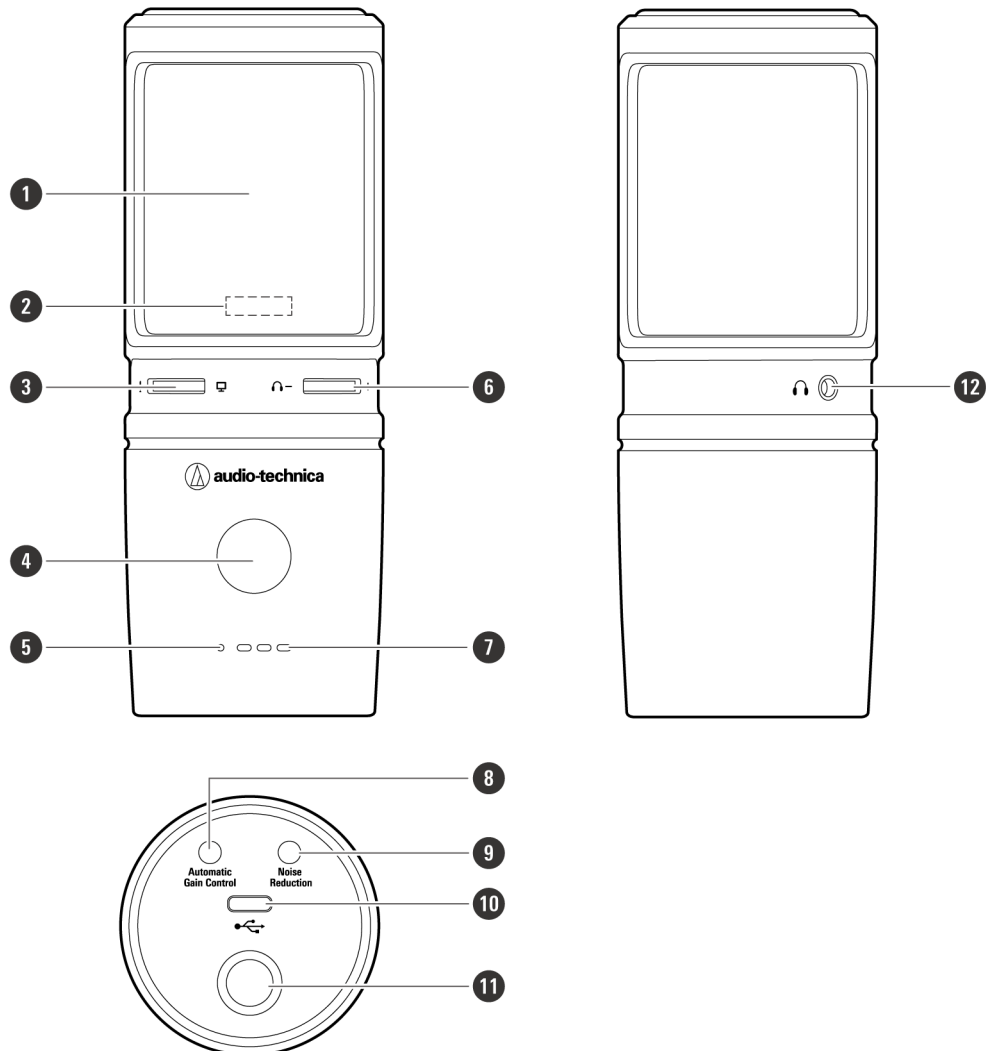

1 Microphone

2 Mute indicator lamp

Lights blue when audio input is enabled. It lights red when the microphone is muted.

3 Mix control dial

Adjusts the balance of the volume level of the sound coming from the computer and the monitored volume level of the audio being input (voice).

4 Touch sensor for mute

Turns the muting of the microphone on/off.

5 Automatic gain control indicator lamp

Lights when the automatic gain control function is on.

6 Headphone level control dial

Adjusts volume of headphone output.

⑦ Noise-reduction indicator lamp

When the noise-reduction function is on, the noise-reduction indicator lamp lights in three levels depending on the level.

⑧ Automatic gain control button

Turns the automatic gain control function on/off. When the function is turned on, the gain is automatically corrected when the input signal is excessive to prevent output distortion.

⑨ Noise-reduction button

Turns the noise-reduction function on/off. When turning it on reduces ambient steady noise. The function level can be set in 3 levels each time the button is pressed.

⑩ USB terminal (USB Type-C™)

Use to connect the included USB cable.

⑪ 3/8" Stand mounting screw hole

Use when attaching the stand.

⑫ Headphone jack (3.5 mm (1/8") stereo mini-jack)

Use to connect headphones.

Included accessories

1

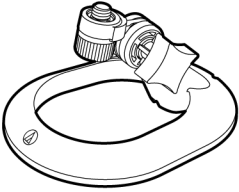

2

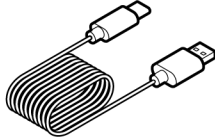

3

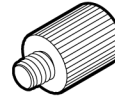

4

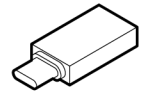

5

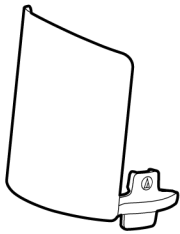

- 1 Stand
- 2 USB cable (USB Type-C to USB Type-A)
- 3 3/8"-16 to 5/8"-27 threaded adapter
- 4 USB conversion adapter (USB Type-A to USB Type-C)
- 5 Pop filter (AT8175)

Setting up the product

For best results, set up the product so that it is facing the sound source. When using it to record voices, place it directly in front of the speaker/singer. Do the same thing when recording sound such as acoustic guitar, drums, or piano. Before using the product, try setting it up in various positions, to discover how best to record sound in your current environment.

Attaching the stand

You can use the stand to place the product on a table or a similar surface.

- 1 Attach the stand to the mounting screw hole on the product, and then turn the screw to secure the parts. Adjust the angle of the product, and then turn the grip of the stand to tighten it.

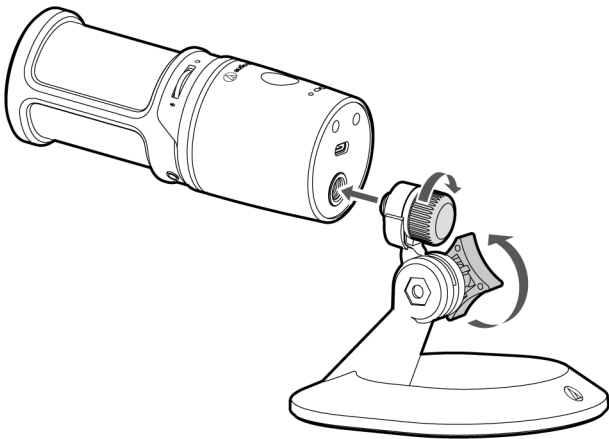

Note

- Use the included 3/8"-16 to 5/8"-27 threaded adapter when installing the product on a commercially available microphone stand.

Attaching the pop filter

- 1 Install the pop filter while slightly widening the mounting area to avoid damaging the microphone.

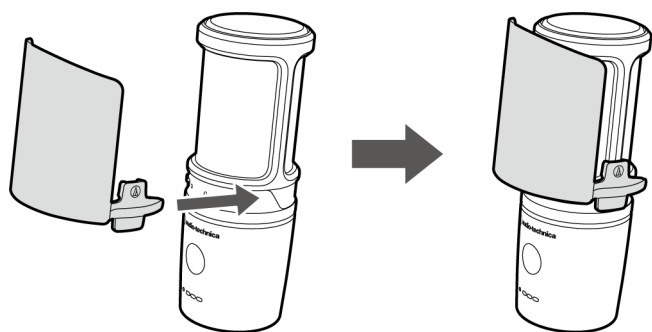

Connection procedure

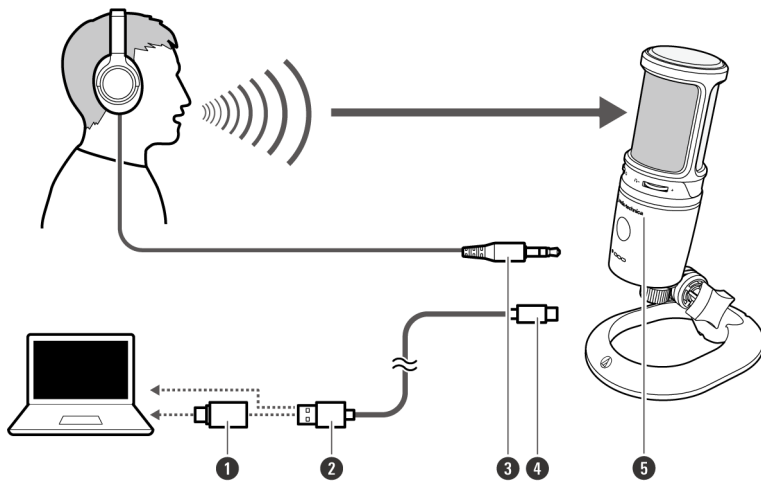

- ❶ USB conversion adapter (USB Type-A to USB Type-C)
- ❷ USB Type-A
- ❸ Headphone input plug
- ❹ USB Type-C
- ❺ Audio-Technica logo

1 Connect the USB cable (USB Type-C side) to the USB terminal on the underside of the product.

2 Connect the USB cable (USB Type-A side) to the computer.

- If necessary, use the USB conversion adapter (USB Type-A to USB Type-C) depending on the USB terminal of the computer you are using. Use the USB conversion adapter for the USB terminal of the computer side. Do not connect it to the USB terminal of the product side.
- If you are using Windows, refer to "Computer settings (Windows)" (p. 1010) to do the settings.
- If you are using Mac, refer to "Computer settings (macOS)" (p. 35) to do the settings.
- Make sure that the mute indicator lamp lights blue (ready for audio input).

3 If you are using headphones, connect the headphones to the headphone jack.

Computer settings (Windows)

For Windows 11

- 1 Use the USB cable to connect the product to a computer.
- 2 Confirm that the mute indicator lamp on the product lights.
 - The computer automatically recognizes the product and the driver is installed on the computer. In the lower right part of the screen, a message appears indicating that new hardware has been found or a notification appears indicating that the driver software has been installed.
- 3 Click "Start Menu" and select "Settings".
- 4 Select "System".

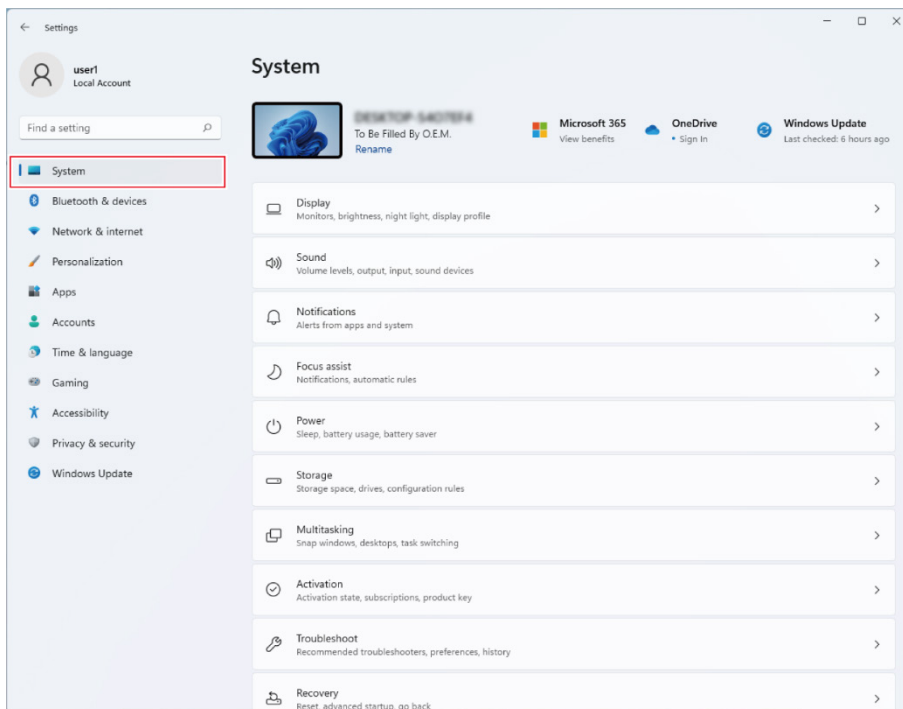

5 Select "Sound".

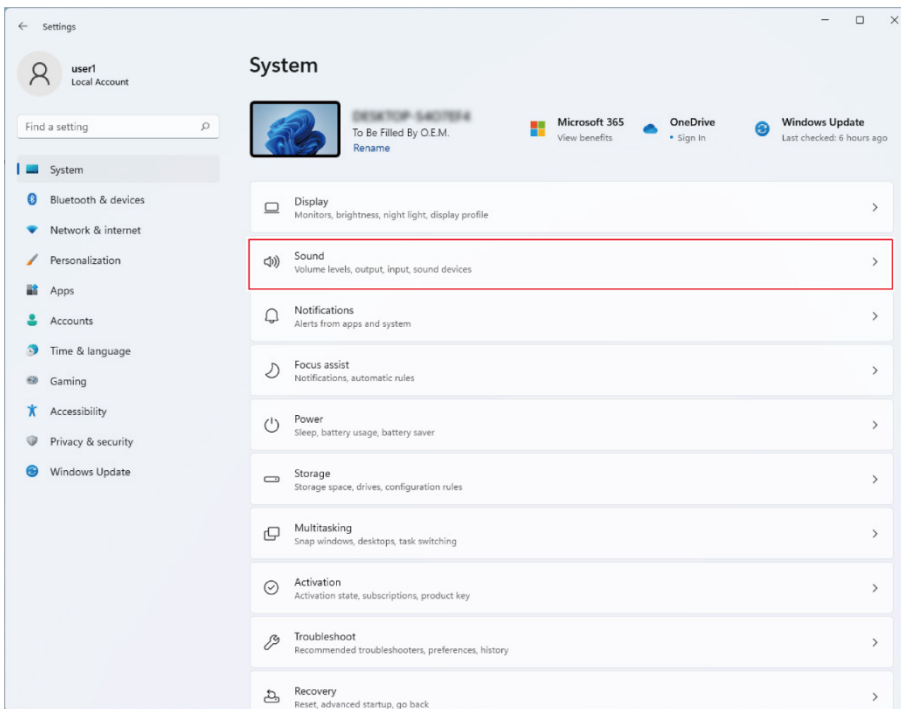

6 Under "Output" and "Input", confirm that the product is selected.

- If a device other than the product is being used as the output device, select this other device from "Choose where to play sound".
- If you are using commercially available recording software to record audio, refer to "Microphone privacy settings" (p. 12) to configure the settings.

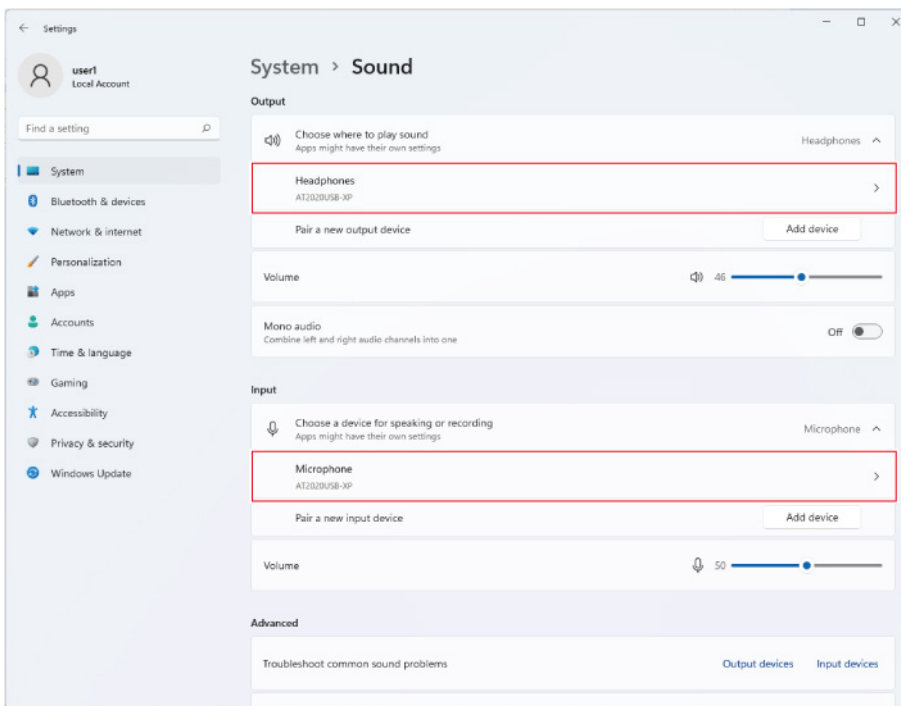

Microphone privacy settings

If you are using commercially available recording software, check the microphone privacy settings.

- 1 Click "Start Menu" and select "Settings".
- 2 Select "Privacy & security".

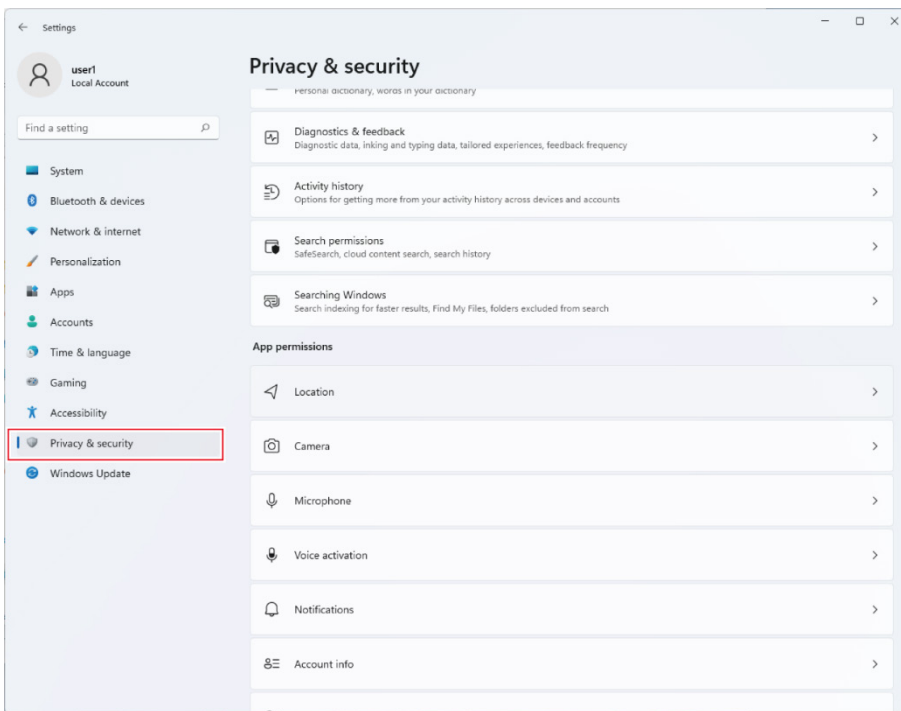

3 Under "App permissions", select "Microphone".

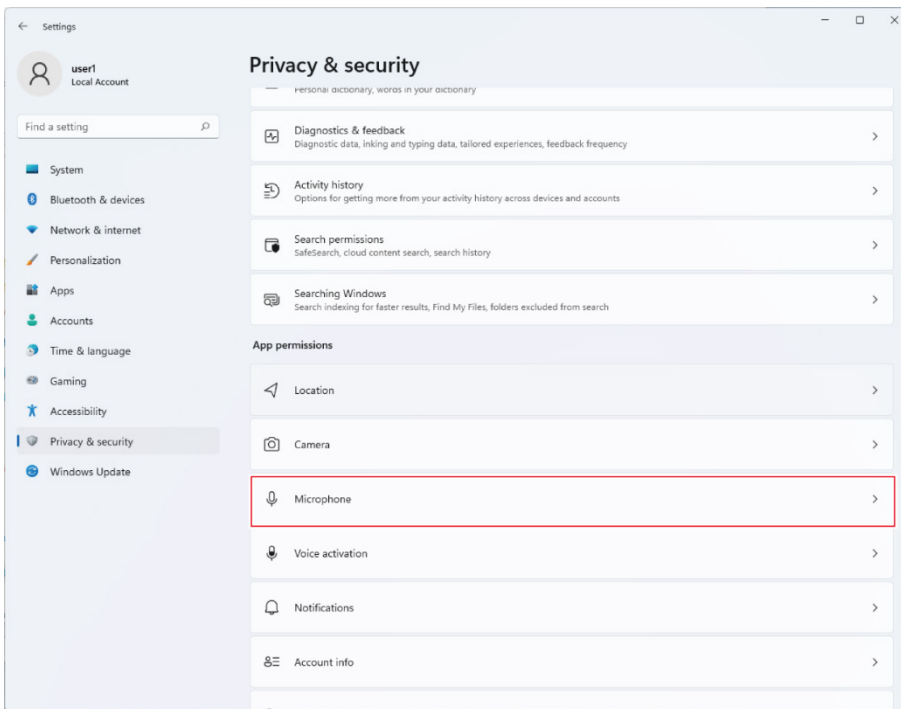

4 Check that "Microphone access" is set to "On".

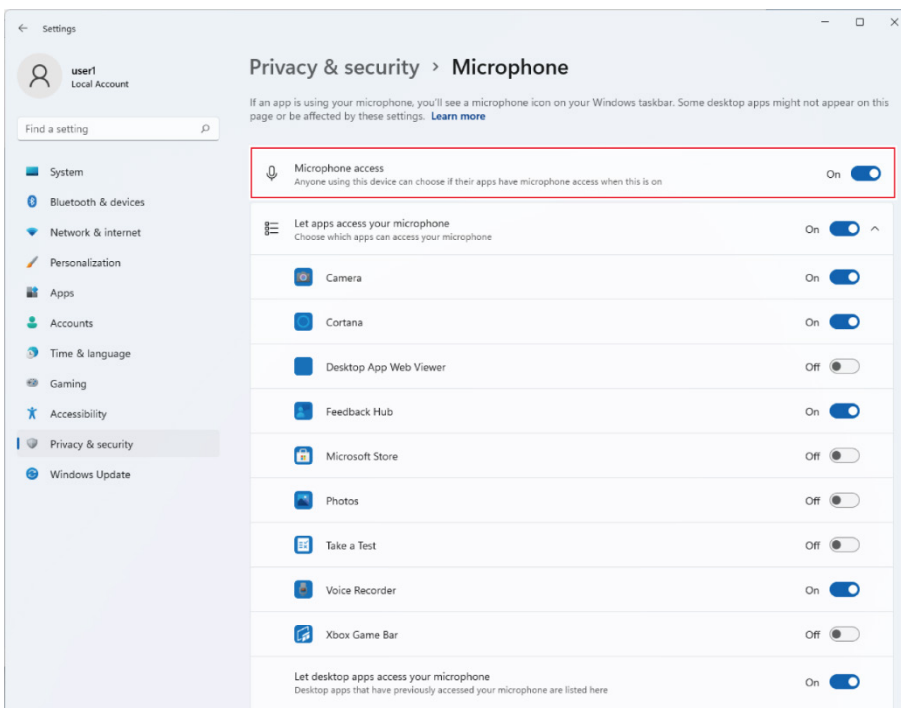

5 Check that "Let apps access your microphone" is set to "On", and then check the list to confirm that the recording software you are using is set to "On".

- If it is not set to "On", change the setting of the recording software you are using to "On".

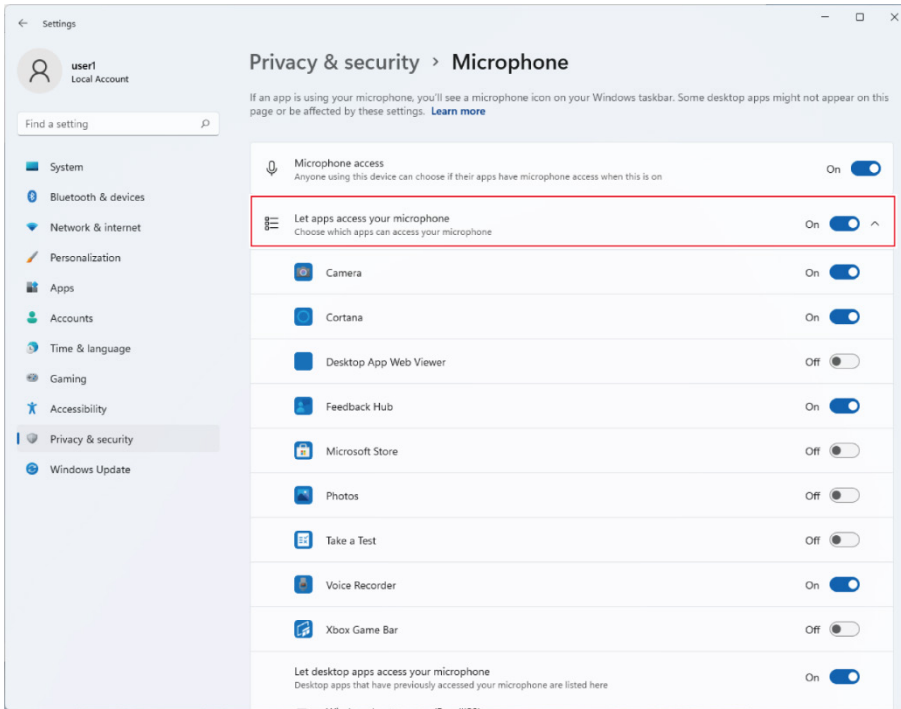

6 Check that "Let desktop apps access your microphone" is set to "On".

- Changing this setting to "On" allows the recording software to access the product.

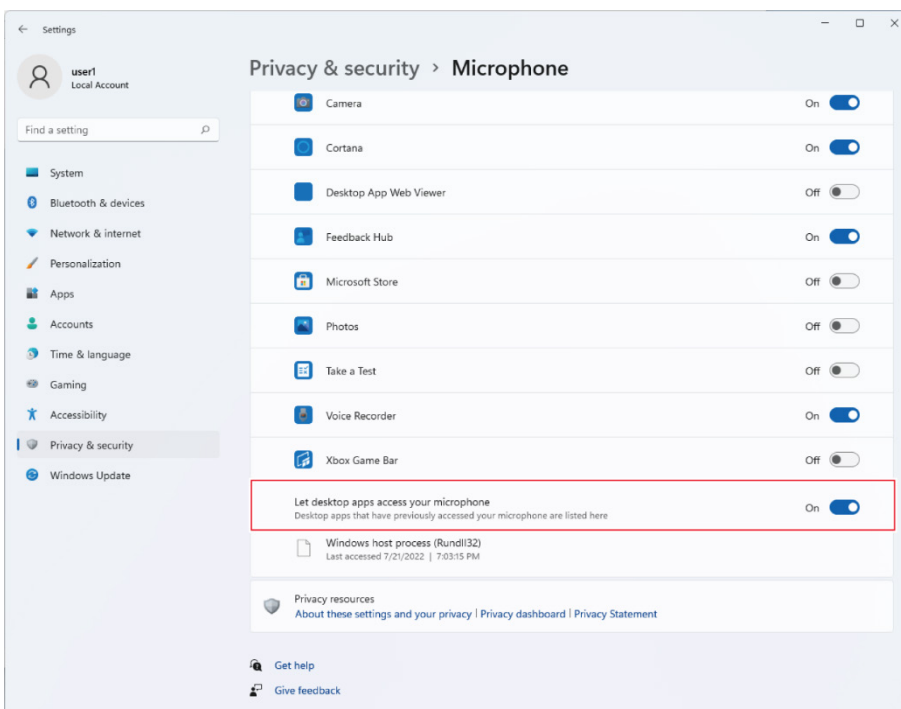

Microphone property settings

To change the microphone level and sample rate of the microphone, configure the following settings.

- 1 Click "Start Menu" and select "Settings".
- 2 Select "System".

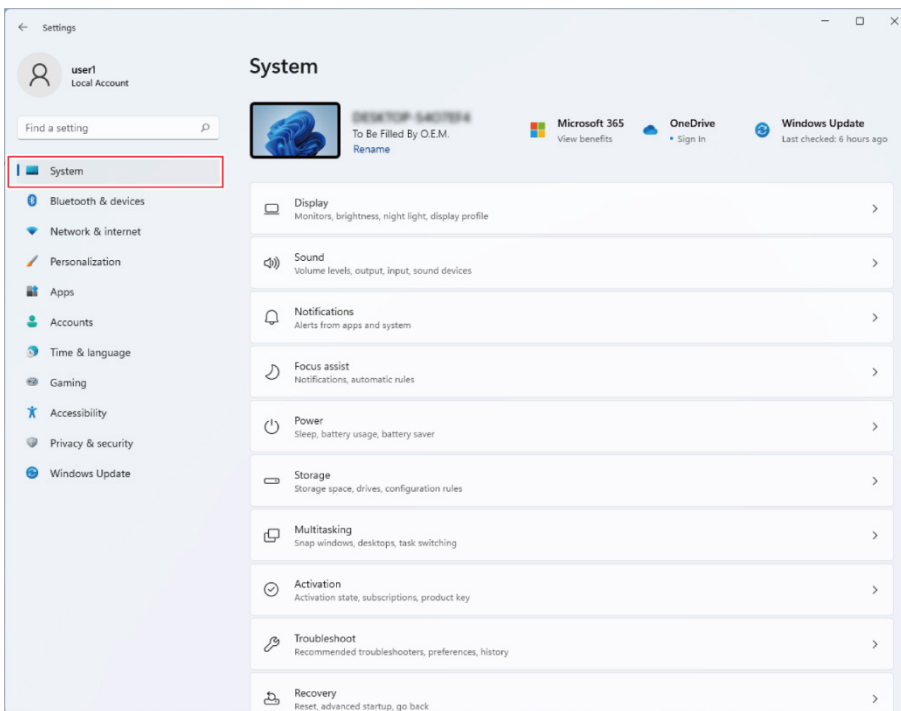

3 Select "Sound".

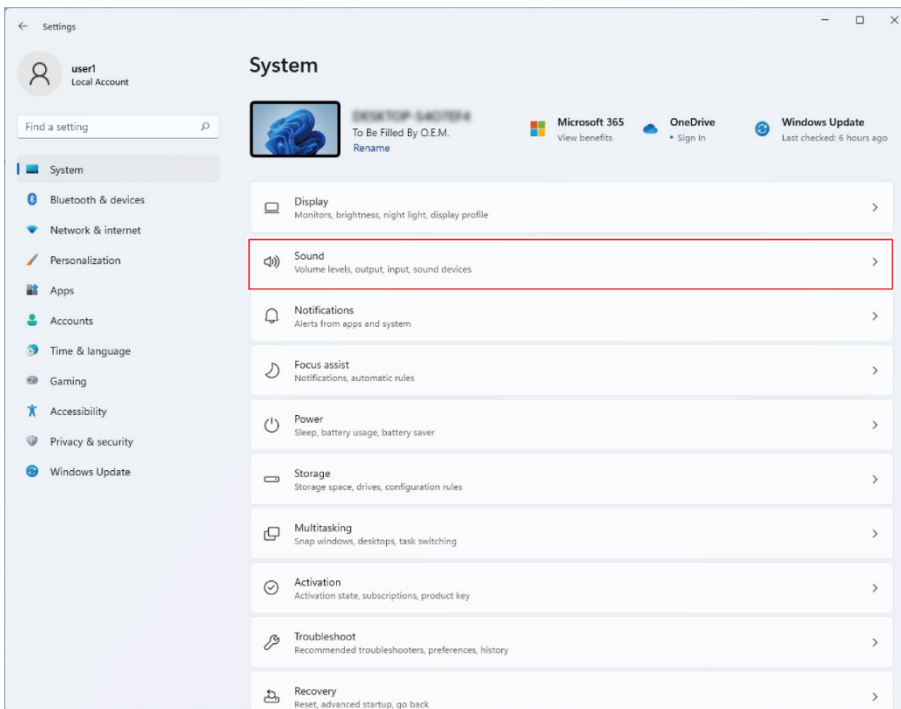

4 Under "Advanced", select "More sound settings".

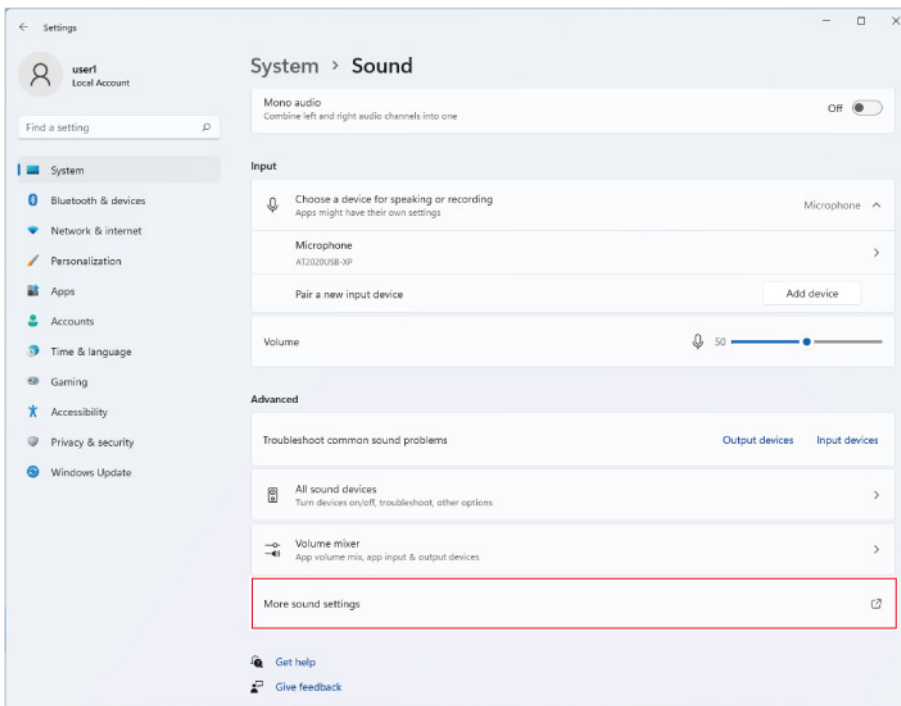

- 5** In the "Playback" tab, confirm that the product is selected.
- If the product is not selected, select the product, and then click "Set Default".

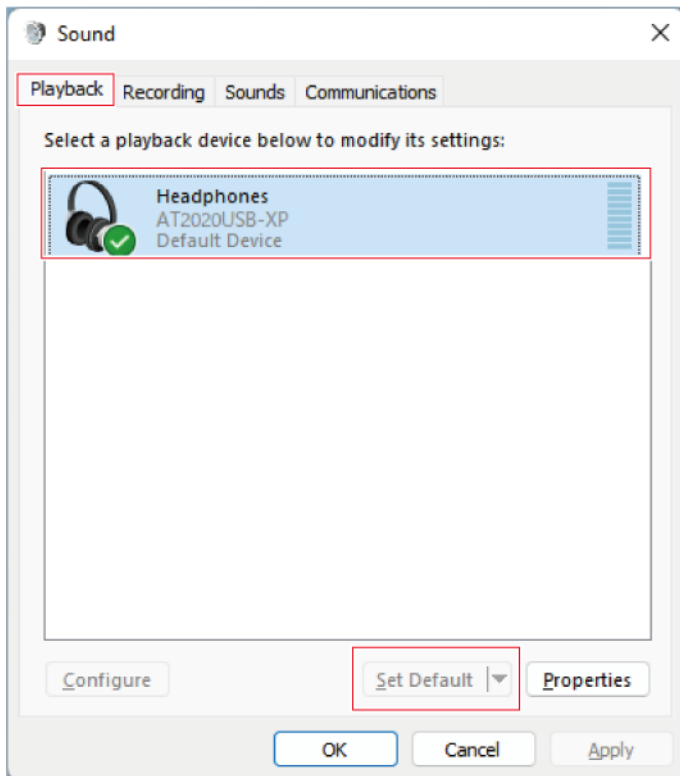

- 6** Double-click the product's icon, and open the properties window.

- 7** Select the "Levels" tab, check that the microphone speaker icon is on, and then click "OK".
- If it is not on, click the microphone speaker icon to turn it on.

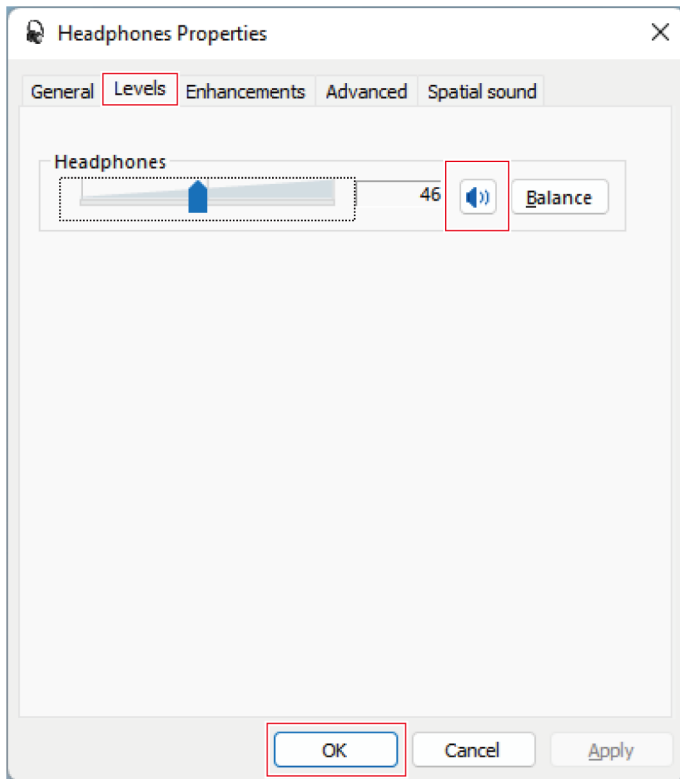

- 8** In the "Recording" tab, confirm that the product is selected.
- If the product is not selected, select the product, and then click "Set Default".

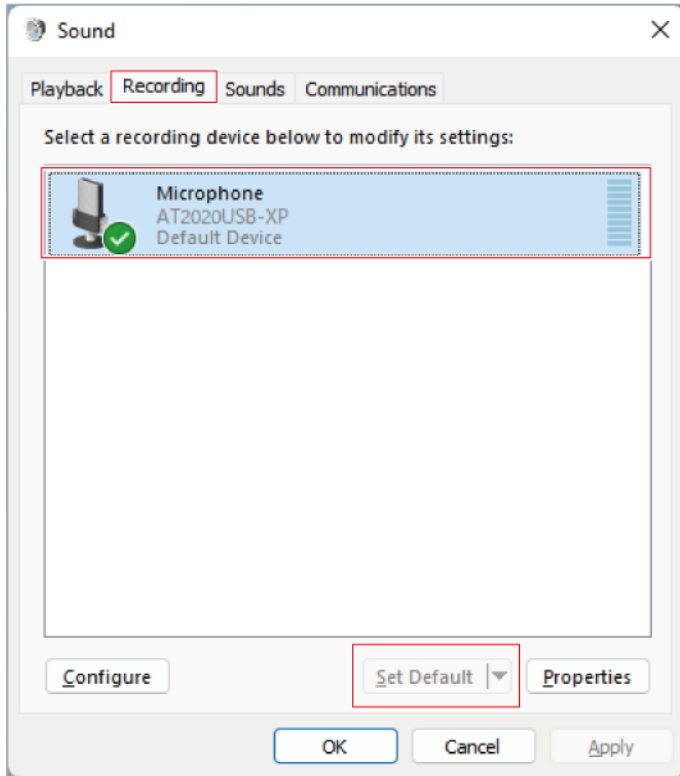

- 9** Double-click the product's icon, and open the "Microphone Properties" window.

- 10** Select the "Levels" tab to adjust the microphone level.
- To adjust the microphone level after you start recording, make the adjustments from this window.
 - This setting is different from the "Volume" setting in the "Sound" window.

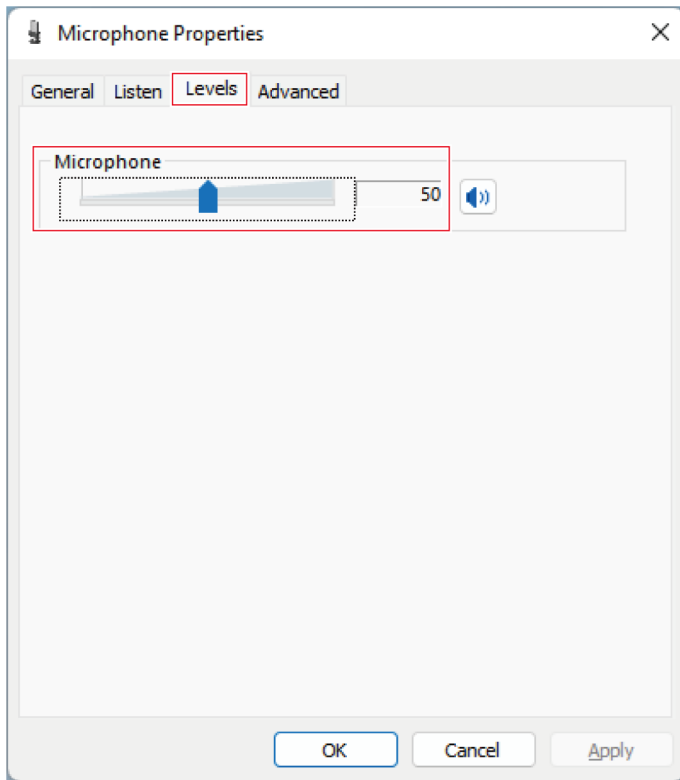

11 To change the microphone sample rate, select the "Advanced" tab, select the sample rate and bit depth under "Default Format", and then click "OK".

- With this product, you can select a sample rate of up to 192 kHz. Selecting a high sample rate may result in high-quality recorded audio data but will also make these files large.
- For stable recording with less load on the computer, change the sample rate to 48 kHz.
- When controlling the microphone from the recording software, select the "Give exclusive mode applications priority" check box under "Exclusive Mode". The sample rate will be set according to the settings of the recording software.

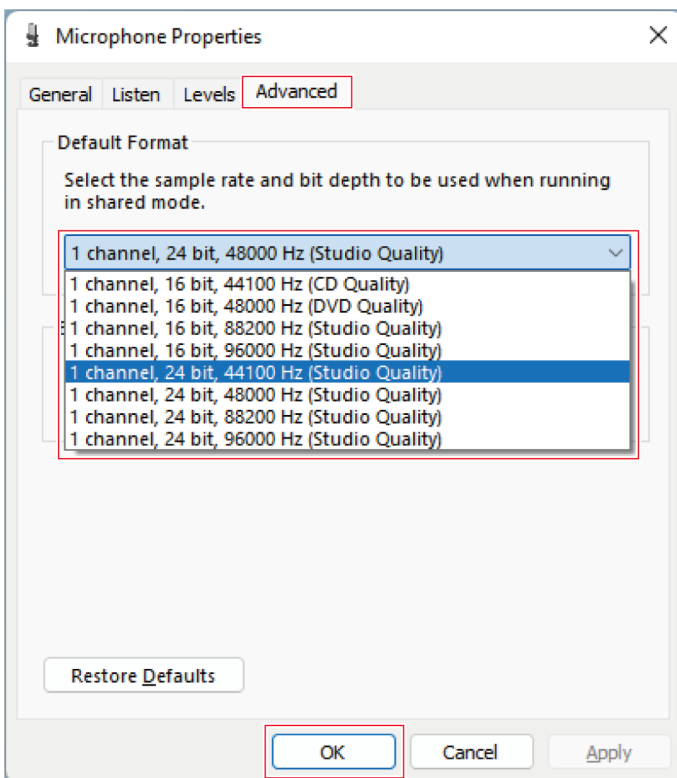

12 When a "Device In Use" message appears, click "Yes".

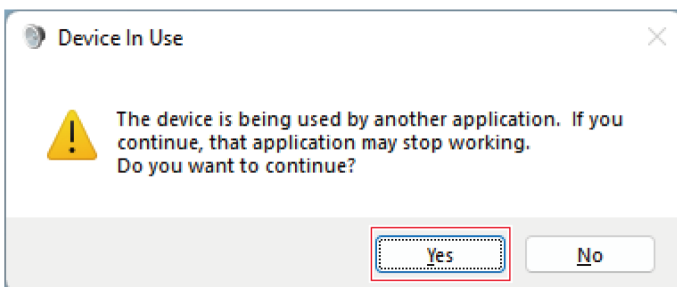

13 Select the "Advanced" tab under the "Playback" tab, select the same sample rate and bit rate that you changed in step 11, and click "OK".

- If you change the sample rate of the microphone, the sampling frequency setting in "Playback/Record" must be the same.

14 When a "Device In Use" message appears, click "Yes".

Caution

- If the mute indicator lamp is blinking, the sampling frequency setting in "Playback/Record" on your Windows PC is different. Match the sampling frequency setting to the correct setting.
- Automatic gain control is available only when the sampling frequency is 44.1 kHz, 48 kHz, 88.2 kHz, or 96 kHz. If the sampling frequency is set to a sampling frequency that cannot be used, the Automatic gain control indicator lamp will blink three times and turn off (indicating an error). Set to a supported sampling frequency.
- Noise-reduction is available only when the sampling frequency is 44.1 kHz or 48 kHz. If the sampling frequency is set to a sampling frequency that cannot be used, the noise-reduction indicator lamp will blink three times and the light turn off (indicating an error). Set to a supported sampling frequency.

For Windows 10

- 1 Use the USB cable to connect the product to a computer.
- 2 Confirm that the mute indicator lamp on the product lights.
 - The computer automatically recognizes the product and the driver is installed on the computer. In the lower right part of the screen, a message appears indicating that new hardware has been found or a notification appears indicating that the driver software has been installed.
- 3 Click "Start Menu" and select "Settings".
- 4 Select "System".

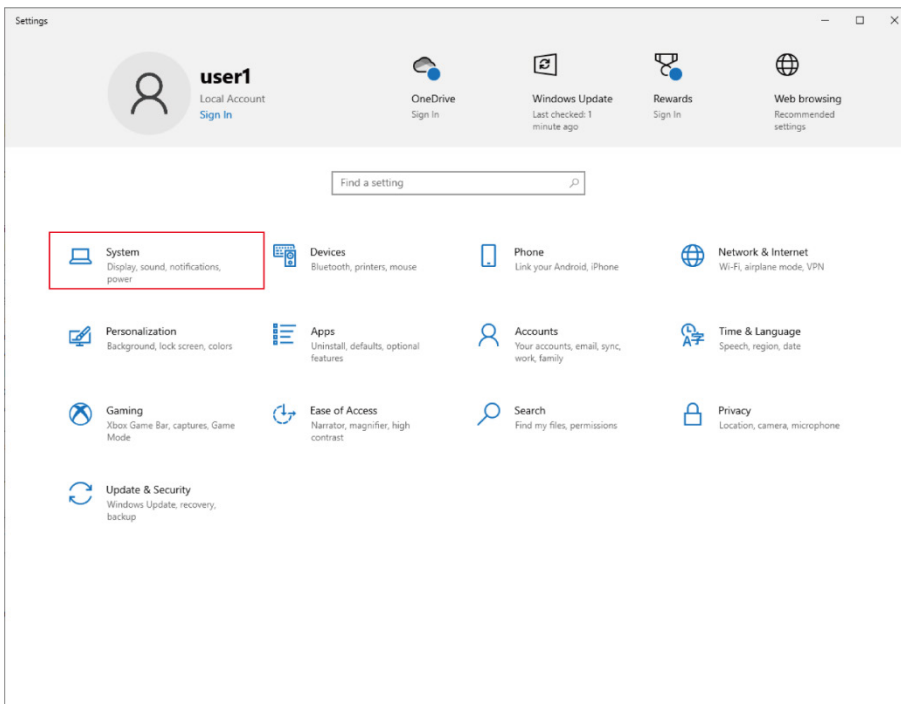

5 Select "Sound".

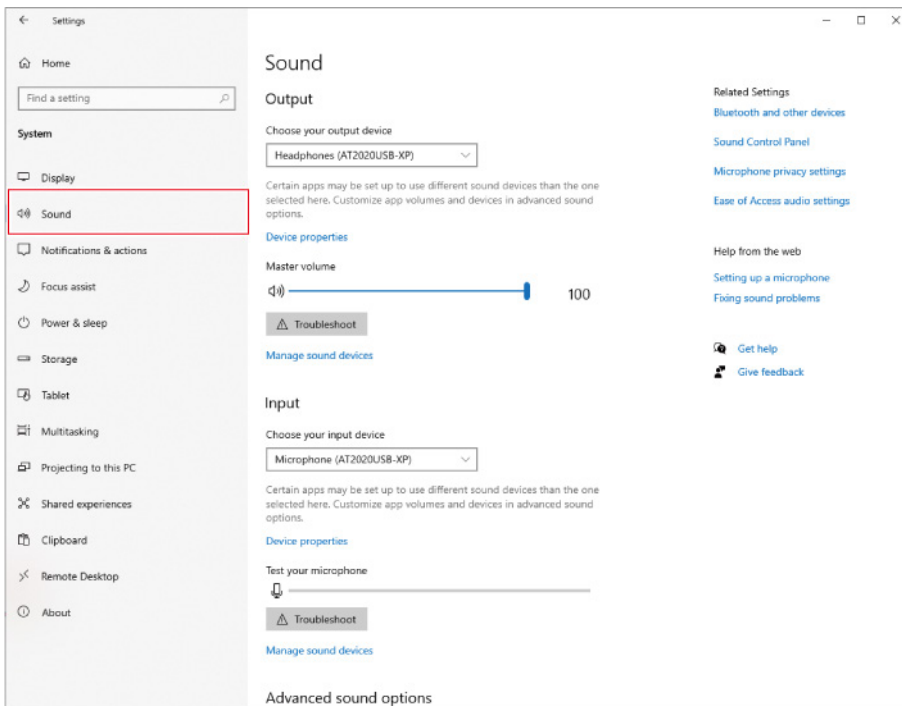

6 Under "Output" and "Input", confirm that the product is selected.

- If a device other than the product is being used as the output device, select this other device from "Choose your output device".
- If you are using commercially available recording software to record audio, refer to "Microphone privacy settings" (p. 2525) to configure the settings.

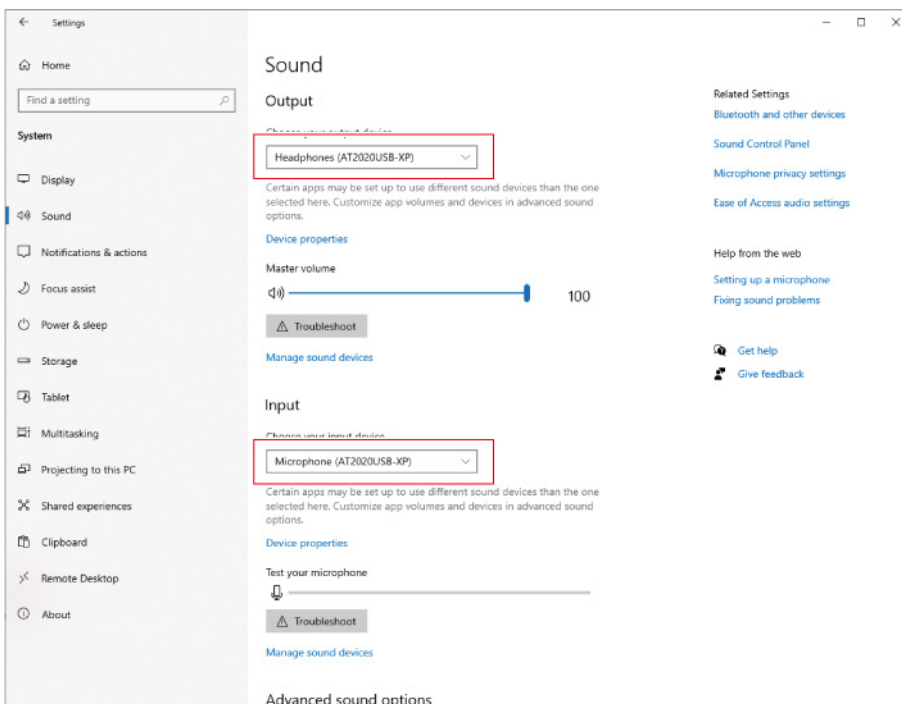

Microphone privacy settings

If you are using commercially available recording software, check the microphone privacy settings.

1 In the "Sound" window, select "Microphone privacy settings".

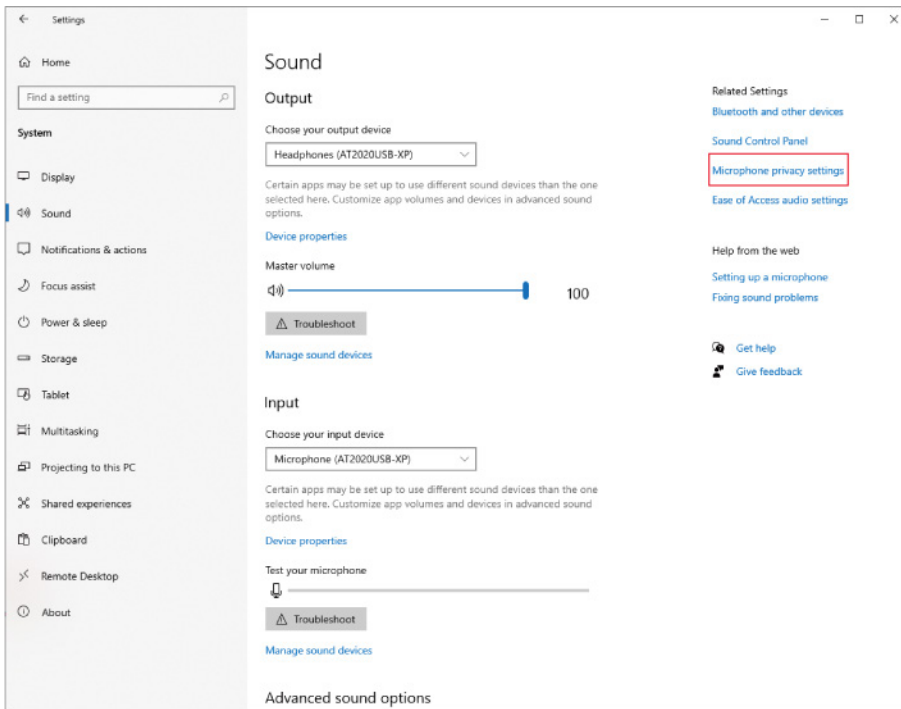

2 Check that "Allow apps to access your microphone" is set to "On".

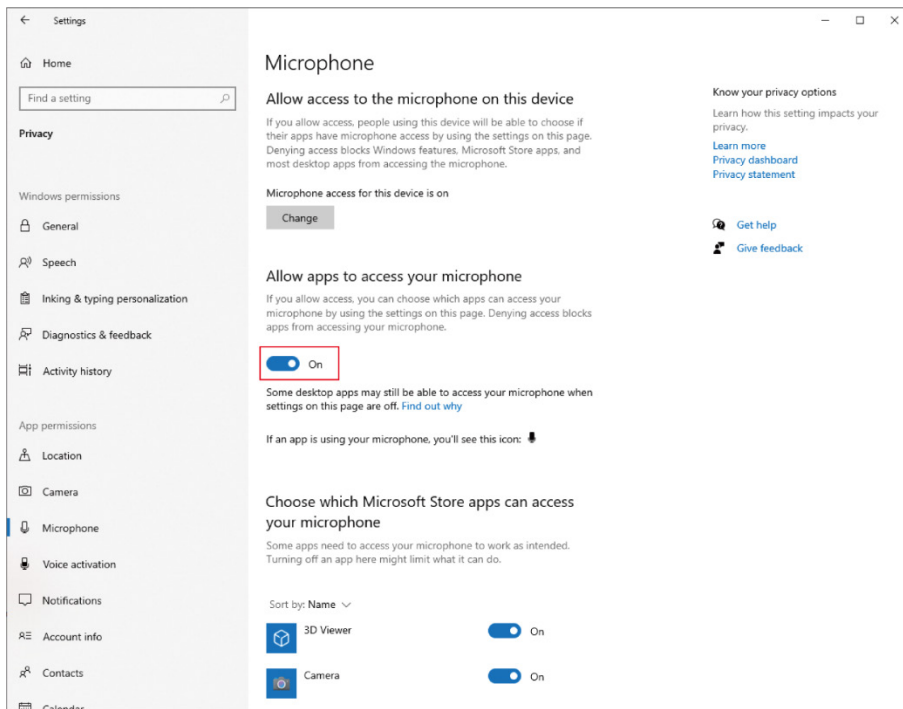

3 Check that the recording software you are using is set to "On" under "Choose which Microsoft Store apps can access your microphone".

- If it is not set to "On", change the setting of the recording software you are using to "On".

- 4 Check that "Allow desktop apps to access your microphone" is set to "On".
- Changing this setting to "On" allows the recording software to access the product.

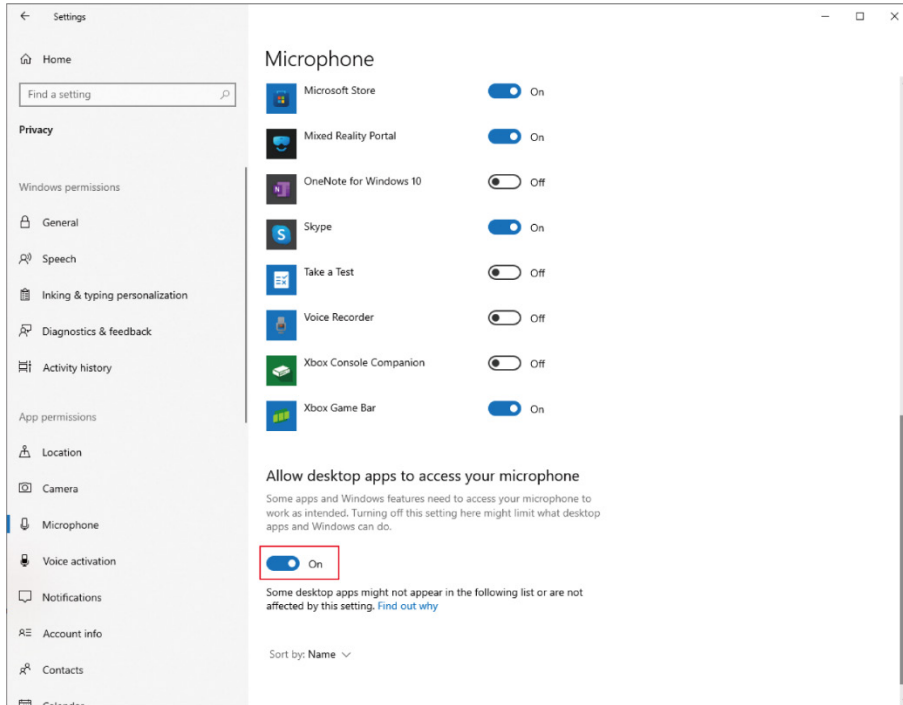

Microphone property settings

To change the microphone level and sample rate of the microphone, configure the following settings.

- 1 In the "Sound" window, select "Sound Control Panel".

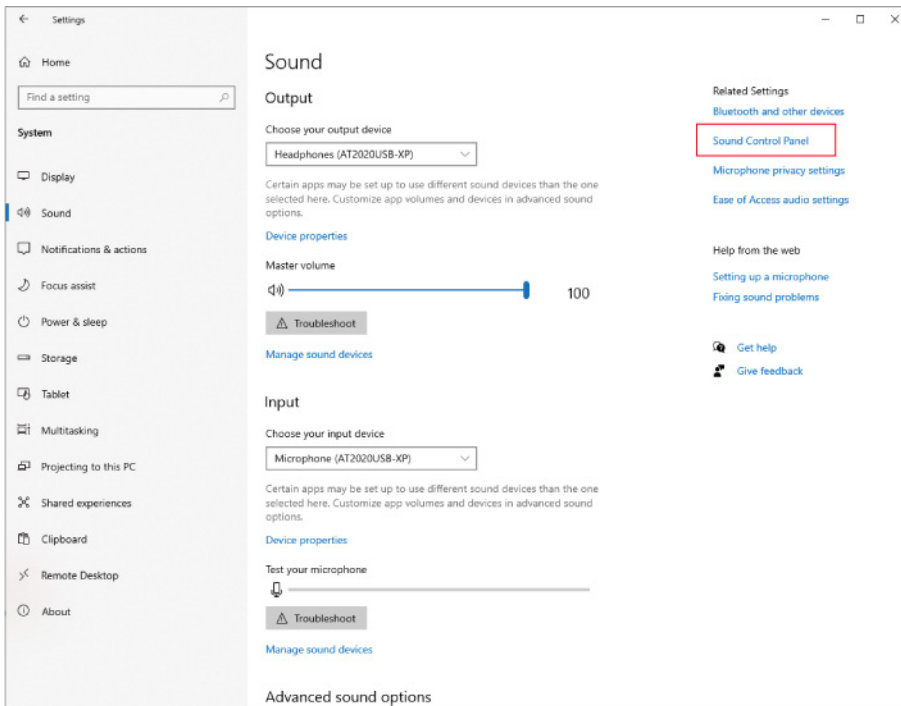

- 2** In the "Playback" tab, confirm that the product is selected.
- If the product is not selected, select the product, and then click "Set Default".

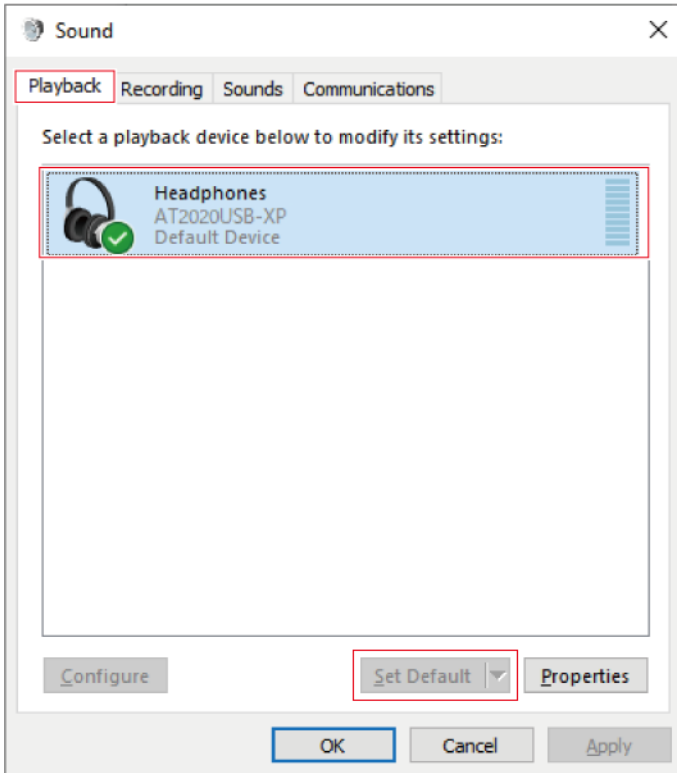

- 3** Double-click the product's icon, and open the properties window.

- 4** Select the "Levels" tab, check that the microphone speaker icon is on, and then click "OK".
- If it is not on, click the microphone speaker icon to turn it on.

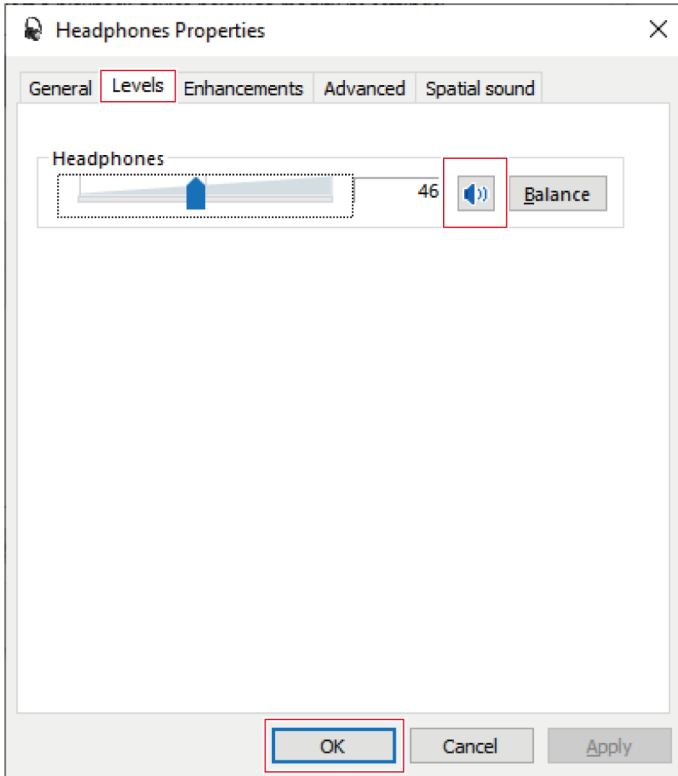

- 5** In the "Recording" tab, confirm that the product is selected.
- If the product is not selected, select the product, and then click "Set Default".

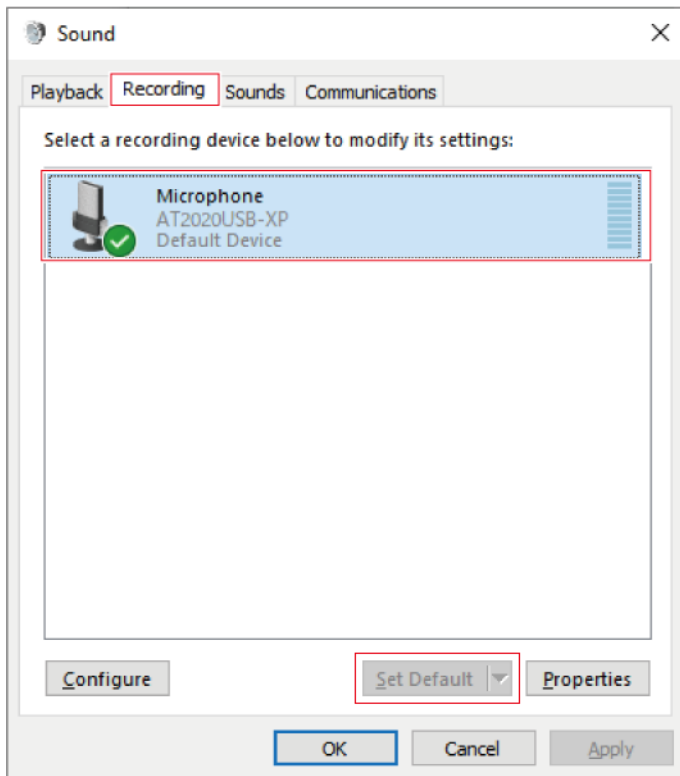

- 6** Double-click the product's icon, and open the properties window.

- 7** Select the "Levels" tab to adjust the microphone level.
- To adjust the microphone level after you start recording, make the adjustments from this window.
 - This setting is different from the "Master volume" setting in the "Sound" window.

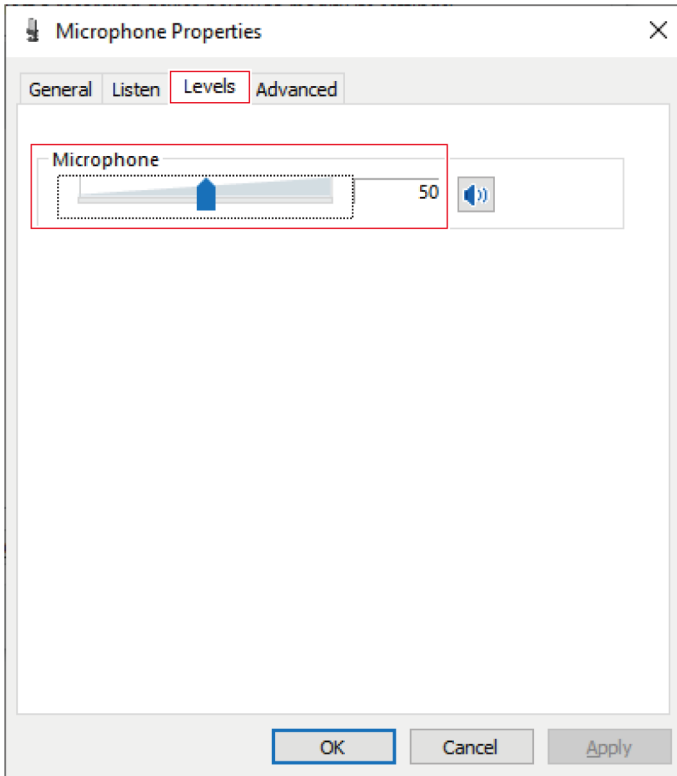

8 To change the microphone sample rate, select the "Advanced" tab, select the sample rate and bit depth under "Default Format", and then click "OK".

- With this product, you can select a sample rate of up to 192 kHz. Selecting a high sample rate may result in high-quality recorded audio data but will also make these files large.
- For stable recording with less load on the computer, change the sample rate to 48 kHz.
- When controlling the microphone from the recording software, select the "Give exclusive mode applications priority" check box under "Exclusive Mode". The sample rate will be set according to the settings of the recording software.

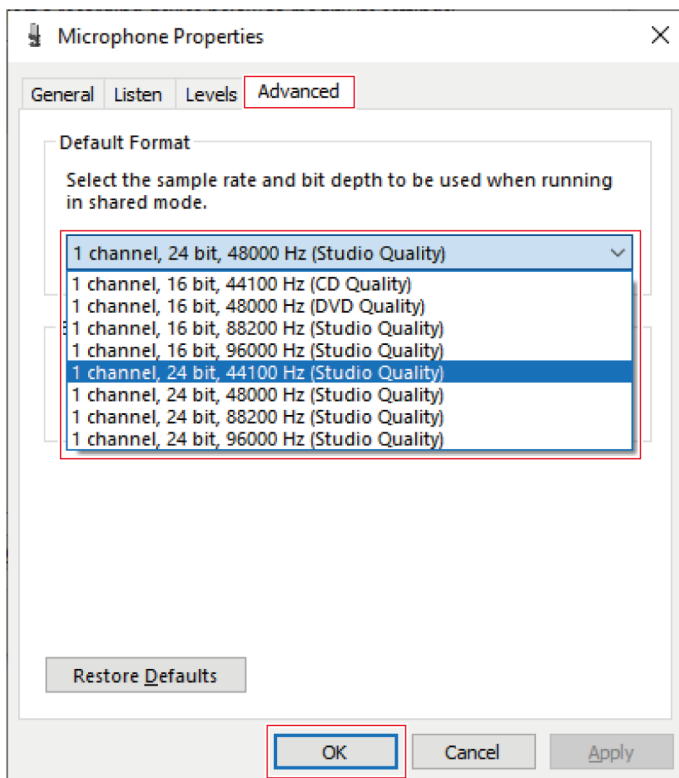

9 When a "Device In Use" message appears, click "Yes".

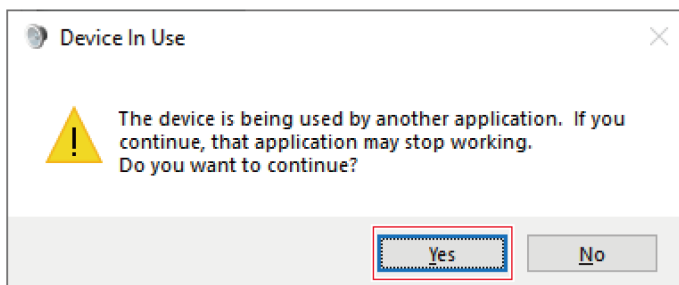

10 Select the "Advanced" tab under the "Playback" tab, select the same sample rate and bit rate that you changed in step 8, and click "OK".

- If you change the sample rate of the microphone, the sampling frequency setting in "Playback/Record" must be the same.

11 When a "Device In Use" message appears, click "Yes".

Caution

- If the mute indicator lamp is blinking, the sampling frequency setting in "Playback/Record" on your Windows PC is different. Match the sampling frequency setting to the correct setting.
- Automatic gain control is available only when the sampling frequency is 44.1 kHz, 48 kHz, 88.2 kHz, or 96 kHz. If the sampling frequency is set to a sampling frequency that cannot be used, the Automatic gain control indicator lamp will blink three times and turn off (indicating an error). Set to a supported sampling frequency.
- Noise-reduction is available only when the sampling frequency is 44.1 kHz or 48 kHz. If the sampling frequency is set to a sampling frequency that cannot be used, the noise-reduction indicator lamp will blink three times and the light turn off (indicating an error). Set to a supported sampling frequency.

Computer settings (macOS)

macOS Ventura

- 1 Use the USB cable to connect the product to a computer.
- 2 Confirm that the mute indicator lamp on the product lights.
 - The computer automatically recognizes the product and the driver is installed on the computer.
- 3 From the Apple icon, select "System Preferences".
- 4 Select "Sound".

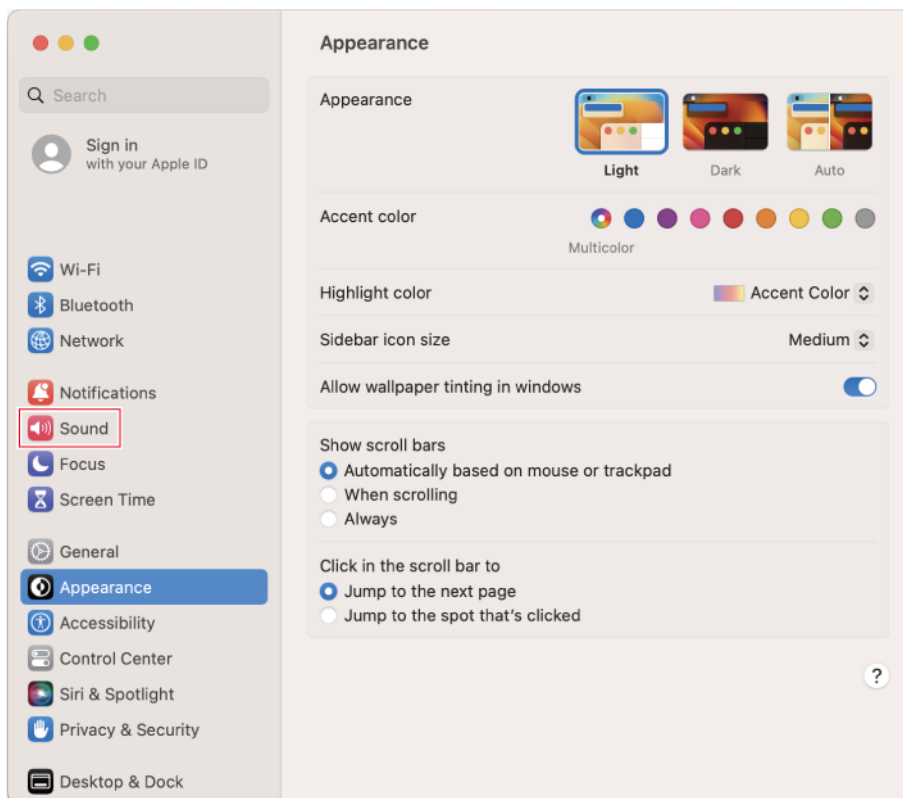

5 In the "Input" tab, confirm that the product is selected.

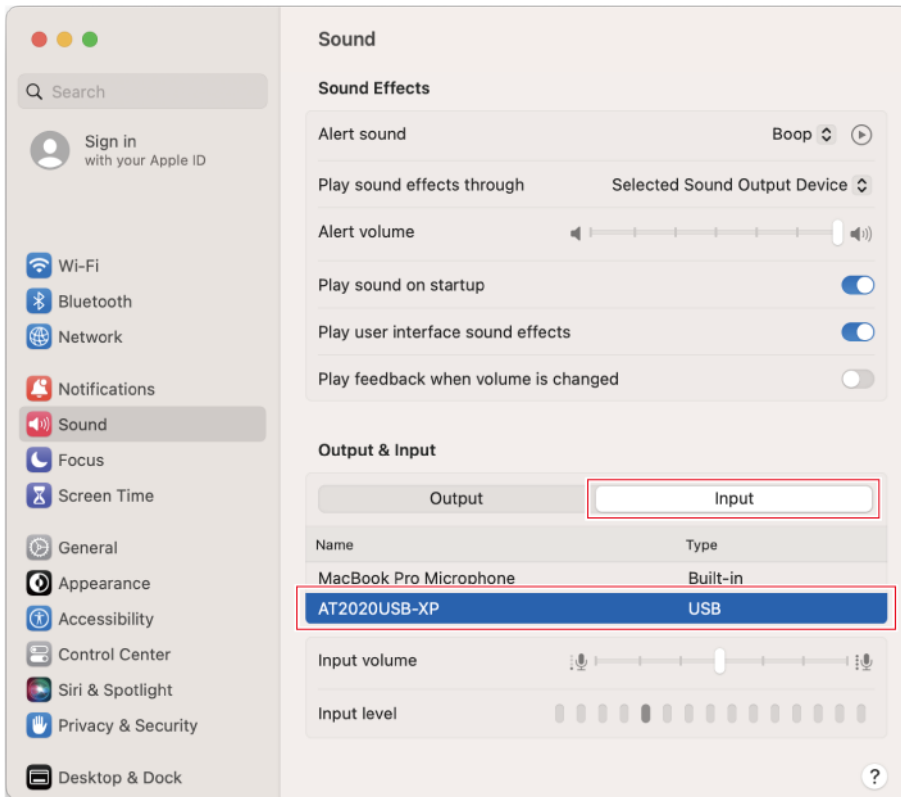

6 Use "Input volume" to adjust the microphone level.

- Speaking into the microphone will cause the "Input level" indicator to move, so you can adjust the input volume while viewing this indicator.

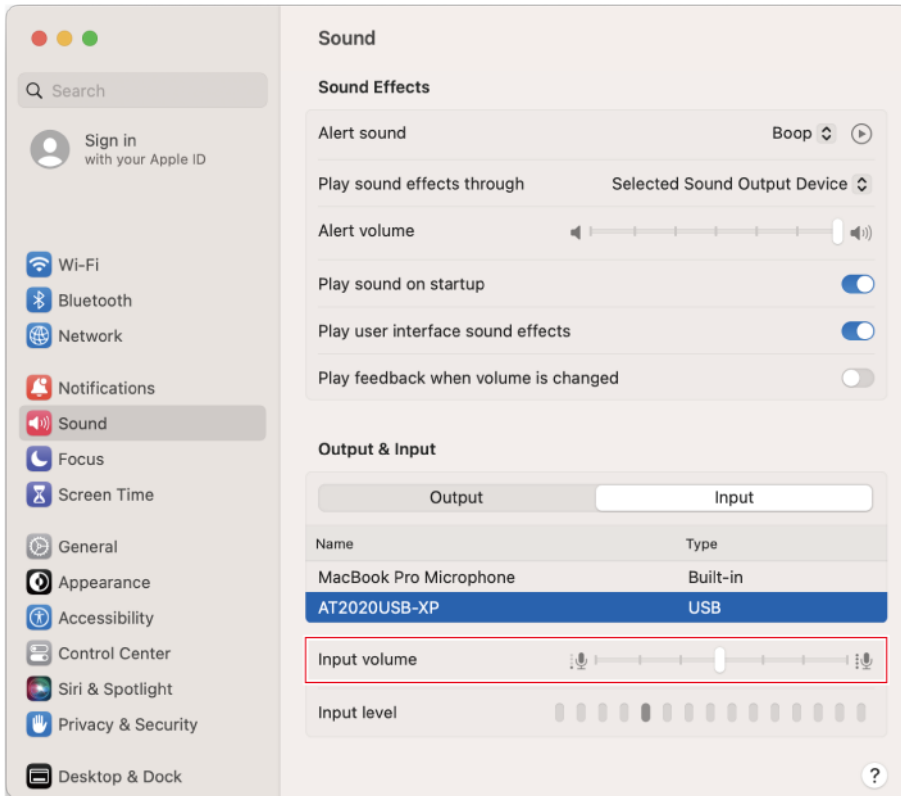

7 In the "Output" tab, confirm that the product is selected.

- If a device other than the product is being used to output sound, select the other device from lists.
- Use "Output volume" to adjust the playback level from the computer.
- You can use "Balance" to set the balance between the left and right volumes.
- If you are using commercially available recording software to record audio, refer to "Privacy and Security settings" (p. 39) settings to configure the settings.

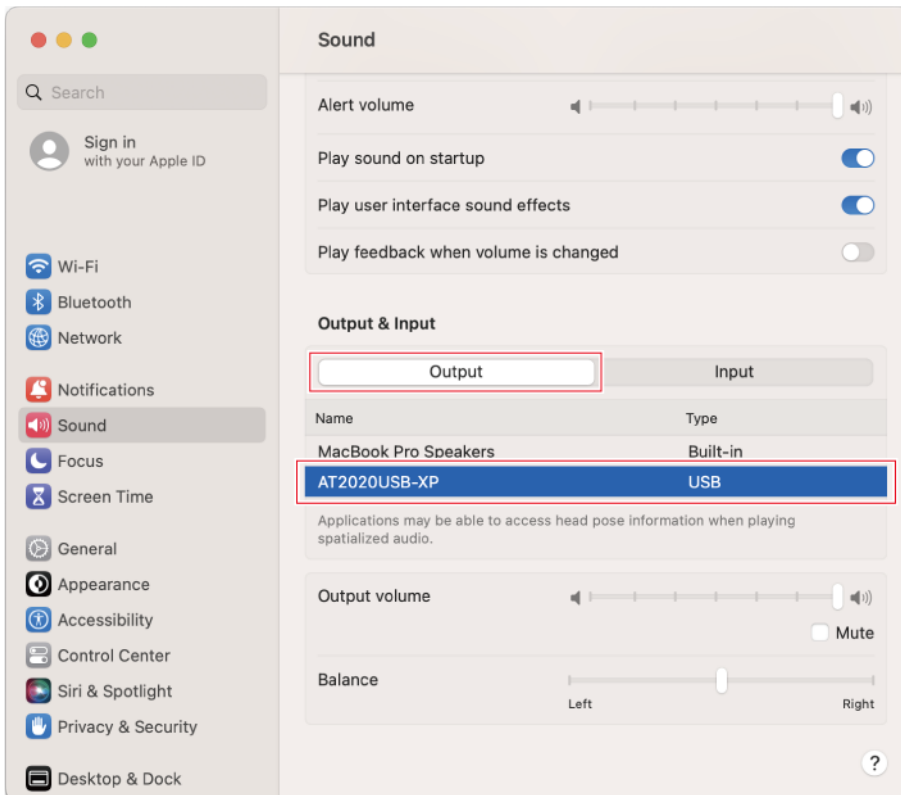

Privacy and Security settings

- If you are using commercially available recording software, check the privacy and security settings.
- If you are using commercially available recording software, use software that is compatible with macOS.

1 In the "System Preferences" window, select "Privacy & Security".

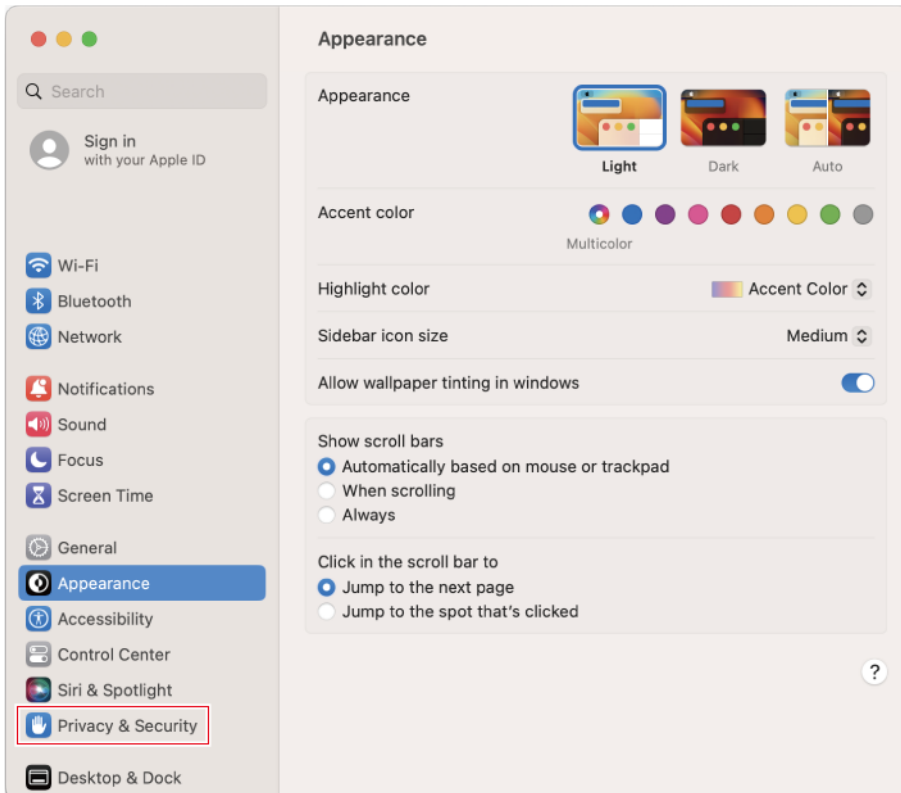

2 In "Privacy", select "Microphone".

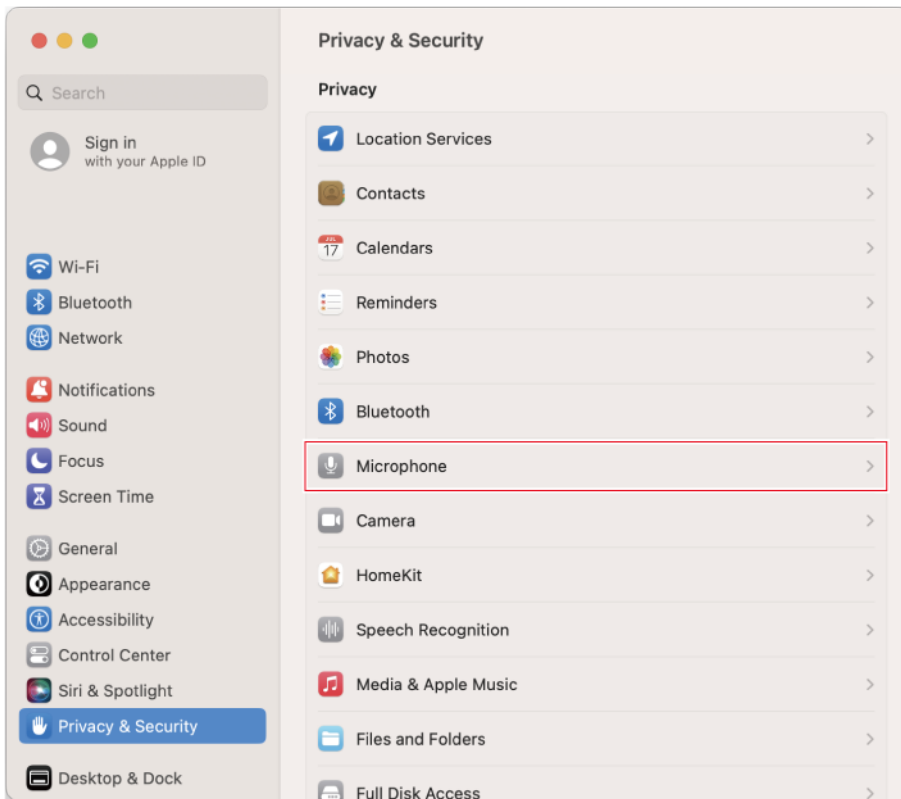

3 Check that the recording software you are using is enabled.

- If it is not enabled, select the check box next to this software.

Audio device settings

To change the sample rate of the microphone, configure the following settings.

- 1 Open "Audio Midi Setup" in the "Utilities" folder in the "Applications" folder.
- 2 Under "Audio Devices", select the product. In the "Input" tab, select the sample rate and bit depth from "Format".
 - Two types of the product are displayed, but select the one that shows "AT2020USB-XP 2 (1 in / 0 outs)".
 - With this product, you can select a sample rate of up to 192 kHz. Selecting a high sample rate may result in high-quality recorded audio data but will also make these files large.
 - For stable recording with less load on the computer, change the sample rate to 48 kHz.
 - Match the sample rate to the value set with the recording software. Failing to do so may result in noise.

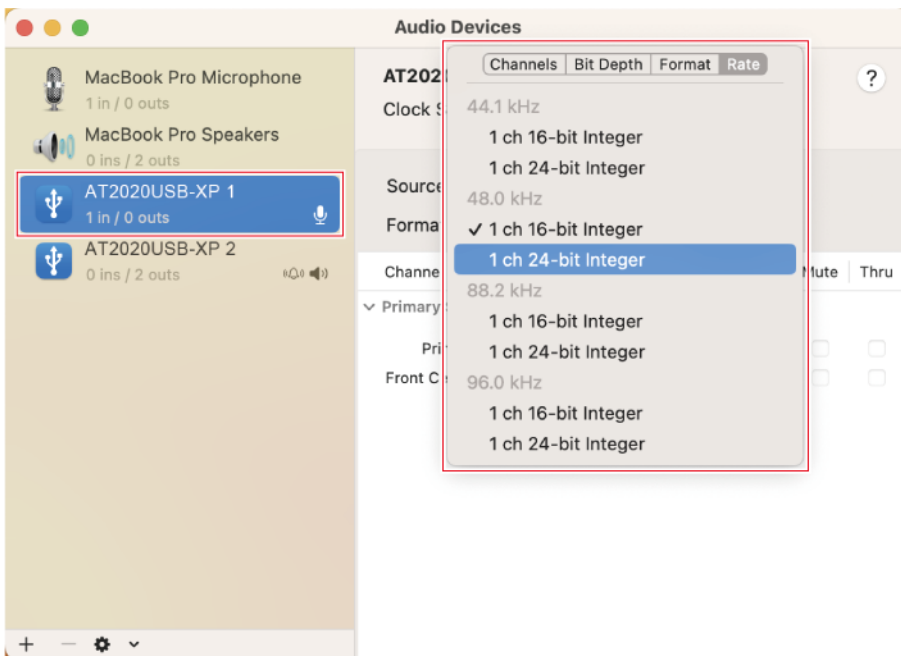

- 3 Select the one that shows "AT2020USB-XP 1 (0 in / 2 outs)" and select the sample rate and bit rate from "Format" in the "Output" tab as in the operation in step 2.
 - Whenever the sample rate of the microphone is changed, the sample rate setting in "Output" or "Input" must be the same.

Caution

- If the mute indicator lamp is blinking, the sample rate setting differs from that set in the "Output" or "Input" tab on the Mac you are using. Match the sample rate settings.
- Automatic gain control is available only when the sampling frequency is 44.1 kHz, 48 kHz, 88.2 kHz, or 96 kHz. If the sampling frequency is set to a sampling frequency that cannot be used, the Automatic gain control indicator lamp will blink three times and turn off (indicating an error). Set to a supported sampling frequency.
- Noise-reduction is available only when the sampling frequency is 44.1 kHz or 48 kHz. If the sampling frequency is set to a sampling frequency that cannot be used, the noise-reduction indicator lamp will blink three times and the light turn off (indicating an error). Set to a supported sampling frequency.

macOS Catalina, macOS Big Sur, and macOS Monterey

- 1 Use the USB cable to connect the product to a computer.
- 2 Confirm that the mute indicator lamp on the product lights.
 - The computer automatically recognizes the product and the driver is installed on the computer.
- 3 From the Apple icon, select "System Preferences".
- 4 Select "Sound".

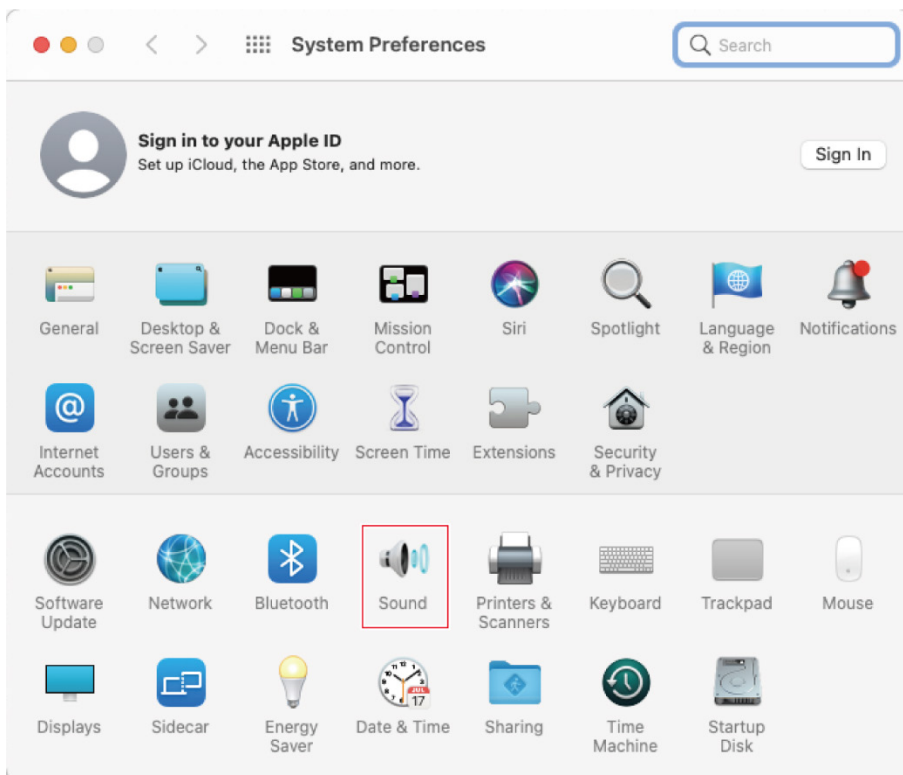

5 In the "Input" tab, confirm that the product is selected.

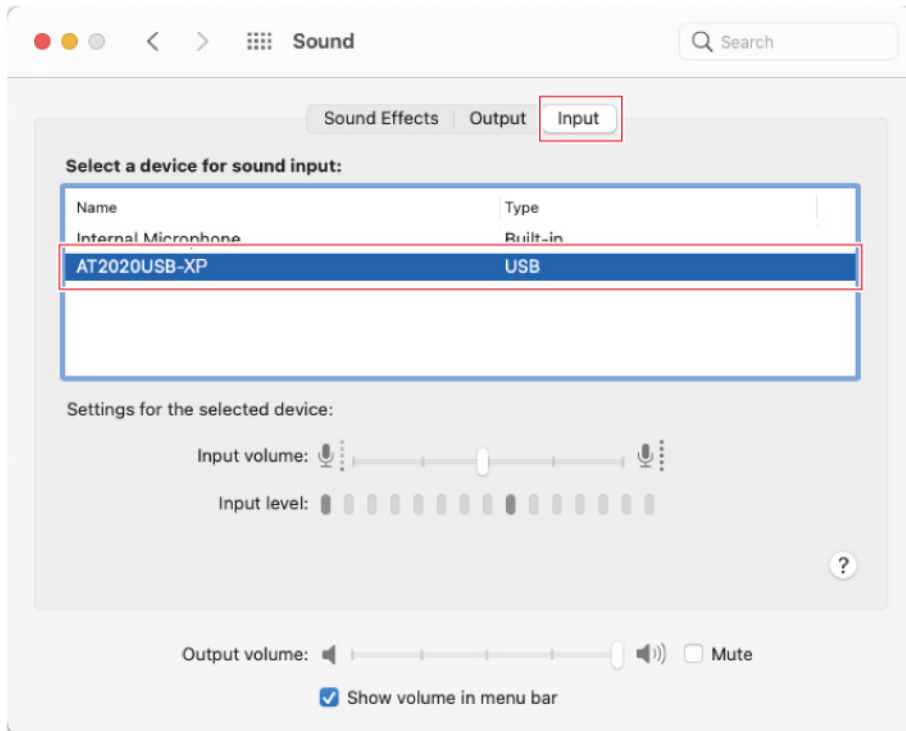

6 Use "Input volume" to adjust the microphone level.

- Speaking into the microphone will cause the "Input level" indicator to move, so you can adjust the input volume while viewing this indicator.
- Use "Output volume" to adjust the volume of the computer's speakers and headphone jack. This is different from adjusting the microphone level.

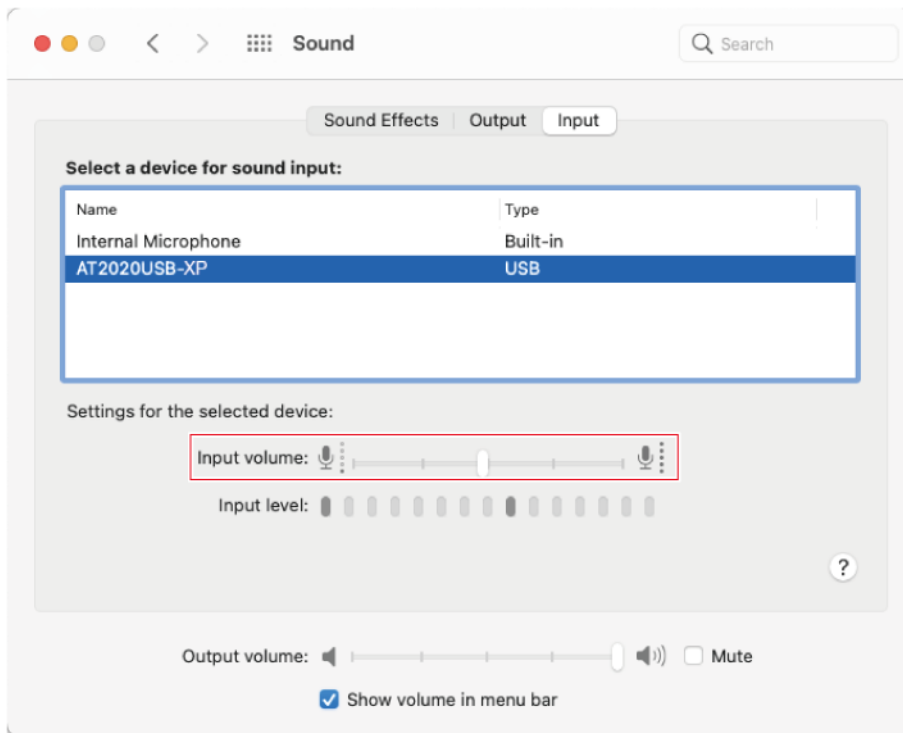

7 In the "Output" tab, confirm that the product is selected.

- If a device other than the product is being used to output sound, select this other device from "Select a device for sound output".
- You can use "Balance" to set the balance between the left and right volumes.
- Use "Output volume" to adjust the playback level from the computer.
- If you are using commercially available recording software to record audio, refer to "Security and privacy settings" (p. 47) to configure the settings.

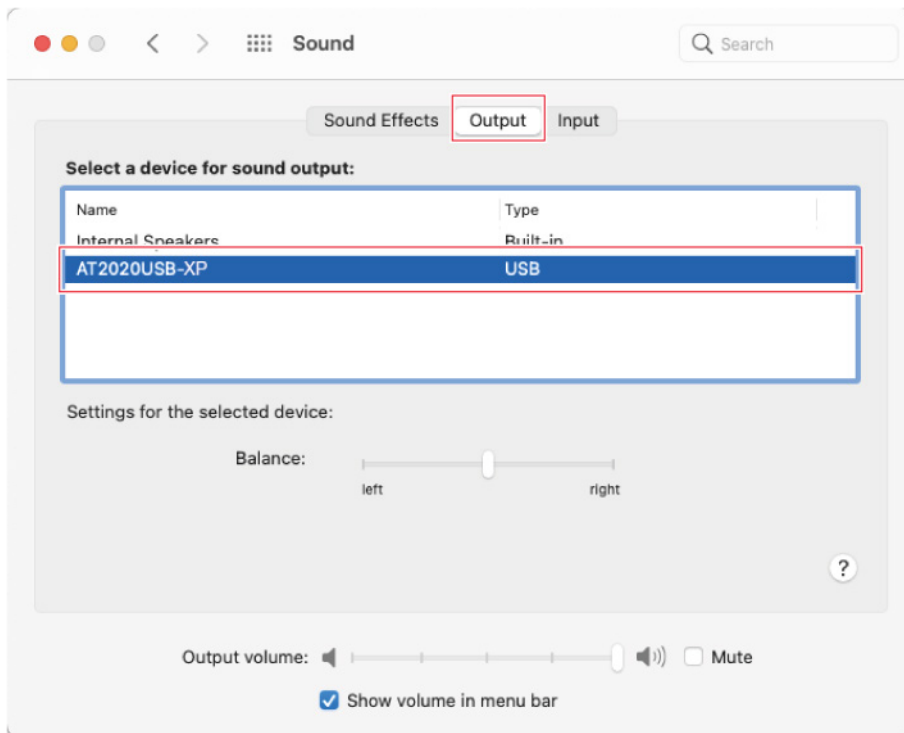

Security and privacy settings

- If you are using commercially available recording software, check the security and privacy settings.
- If you are using commercially available recording software, use software that is compatible with macOS.

1 In the "System Preferences" window, select "Security & Privacy".

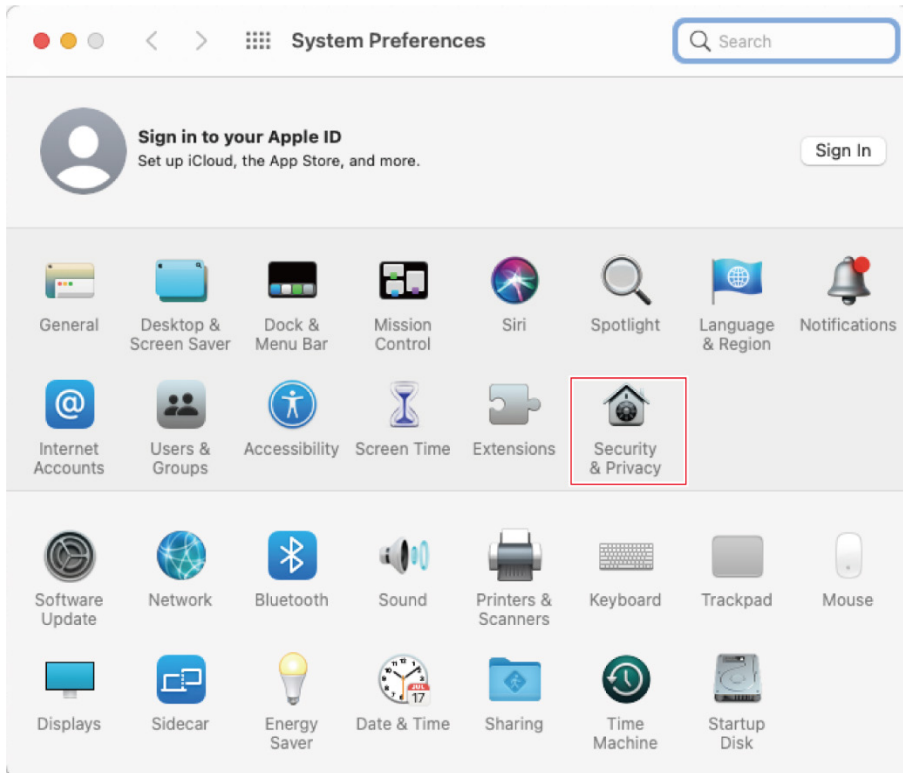

2 In the "Privacy" tab, select "Microphone".

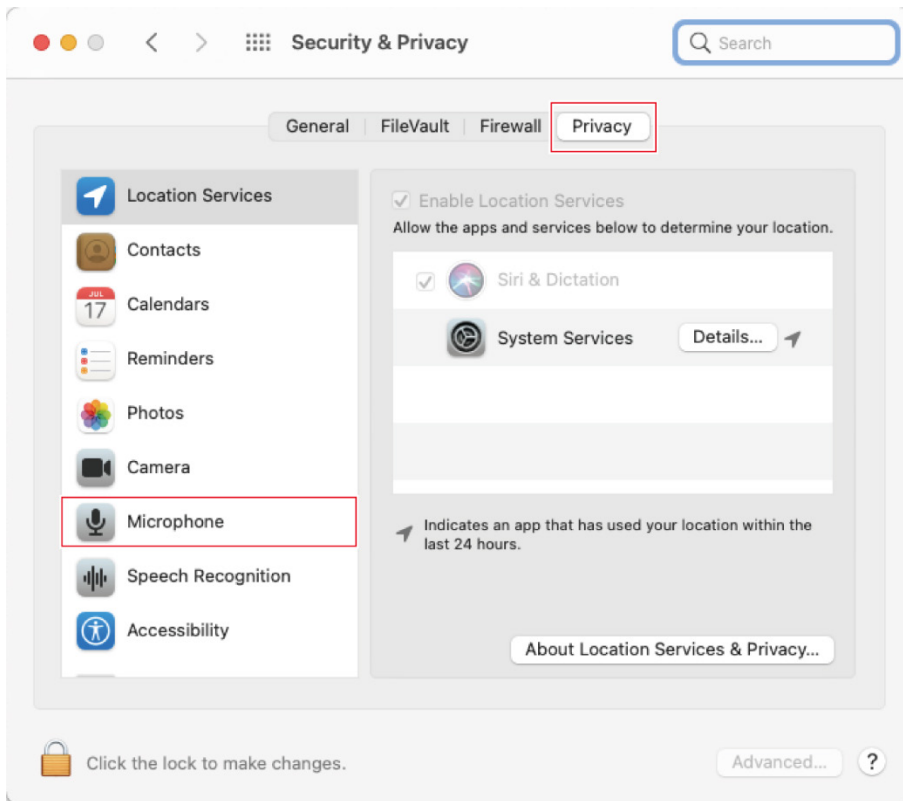

3 Check that the recording software you are using is enabled.

- If it is not enabled, select the check box next to this software.
- To change the "Security & Privacy" settings, you have to unlock them with the icon in the lower-left corner of the screen. Clicking this icon displays a screen for unlocking the settings. Enter the user name and password, and then click "Unlock". After changing the settings, lock them.

Audio device settings

To change the sample rate of the microphone, configure the following settings.

- 1 Open "Audio Midi Setup" in the "Utilities" folder in the "Applications" folder.
- 2 Under "Audio Devices", select the product. In the "Input" tab, select the sample rate and bit depth from "Format".
 - Two types of the product are displayed, but select the one that shows "AT2020USB-XP 1 (1 in / 0 outs)".
 - With this product, you can select a sample rate of up to 192 kHz. Selecting a high sample rate may result in high-quality recorded audio data but will also make these files large.
 - For stable recording with less load on the computer, change the sample rate to 48 kHz.
 - Match the sample rate to the value set with the recording software. Failing to do so may result in noise.

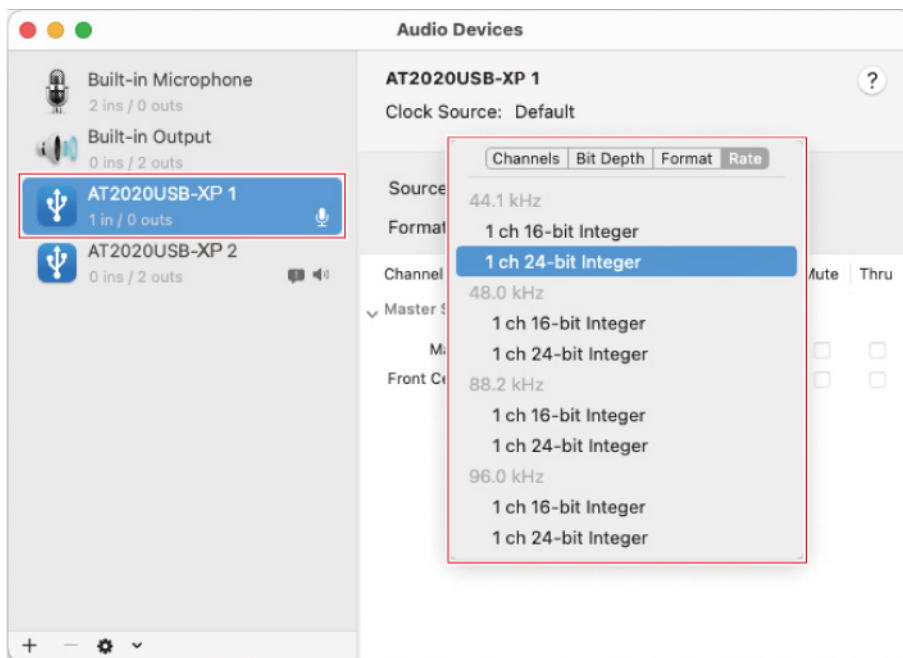

- 3 Select the one that shows "AT2020USB-XP 2 (0 in / 2 outs)" and select the sample rate and bit rate from "Format" in the "Output" tab as in the operation in step 2.
 - Whenever the sample rate of the microphone is changed, the sample rate setting in "Output" or "Input" must be the same.

Caution

- If the mute indicator lamp is blinking, the sample rate setting differs from that set in the "Output" or "Input" tab on the Mac you are using. Match the sample rate settings.
- Automatic gain control is available only when the sampling frequency is 44.1 kHz, 48 kHz, 88.2 kHz, or 96 kHz. If the sampling frequency is set to a sampling frequency that cannot be used, the Automatic gain control indicator lamp will blink three times and turn off (indicating an error). Set to a supported sampling frequency.
- Noise-reduction is available only when the sampling frequency is 44.1 kHz or 48 kHz. If the sampling frequency is set to a sampling frequency that cannot be used, the noise-reduction indicator lamp will blink three times and the light turn off (indicating an error). Set to a supported sampling frequency.

Using the product

Microphone orientation

- To use the product, face towards the side that has the Audio-Technica logo while speaking.
- Set this product and the sound source nearby. It is more difficult to pick up noise other than the target sound source.
- If wind or breath noise is present, move the product slightly away from the front of the sound source and point it toward the speaker.

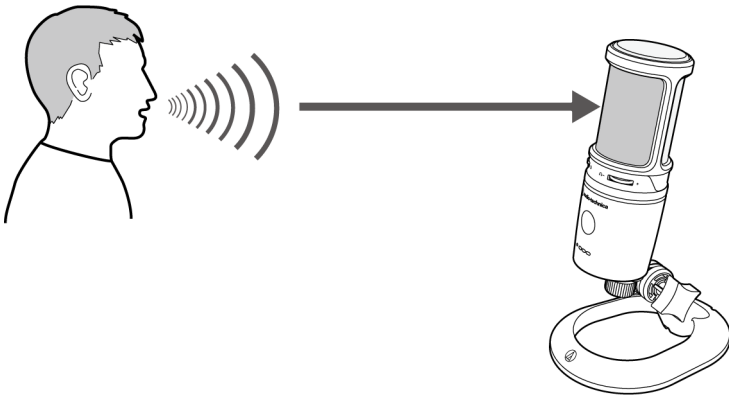

Using software for recording

Software for recording is not included with the product. To use the product to record audio, use separate recording software. You may need to set up the recording software, such as by setting the audio input and output. For details, see the User Manual for the recording software.

Adjusting the microphone level

To get the best performance, you need to appropriately adjust the microphone level of the product. If the sound is distorted, or the recording software you are using is always at peak levels, then decrease the microphone level of the product in the settings on the control panel (system preferences for macOS) or the settings for the recording software you are using. If you feel that the product's microphone level is insufficient, then increase the microphone level of the product in the settings on the control panel (system preferences for macOS) or the settings for the recording software you are using. After that, you do not need to adjust the microphone level of the product, unless the volume of the sound source varies greatly.

Connecting and using the headphones

You can monitor sounds being recorded by connecting headphones to the headphone jack. Also, you can directly monitor your own voice from the product while listening to a sound source from your computer.

1 Connect the headphones to the headphone jack.

2 Turn the headphone level control dial to adjust the volume.

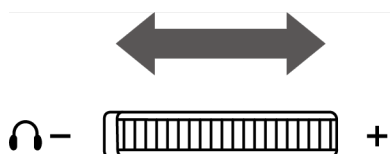

Note

- The headphone level control dial adjusts the volume of the headphone output; it does not adjust the microphone level.

Using the mix control dial

The product allows you to directly monitor your own voice from the product while listening to a sound source from your computer. You can use the mix control dial to adjust the balance of the volume level of the sound source stored on the computer and the monitored volume level of the audio being input.

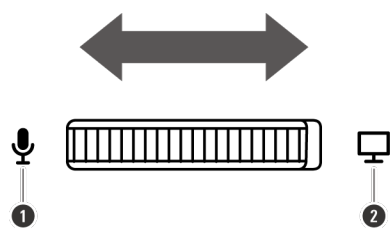

- 1** Turning the dial toward the microphone side increases the monitored volume level of the audio being input.
- 2** Turning the dial toward the computer side increases the volume level of the sound source stored on the computer.

Muting the microphone

Turn the muting of the microphone on/off.

- 1 Touch the touch sensor for mute.
 - Each time you touch this control, muting turns on (lights red) or off (lights blue).

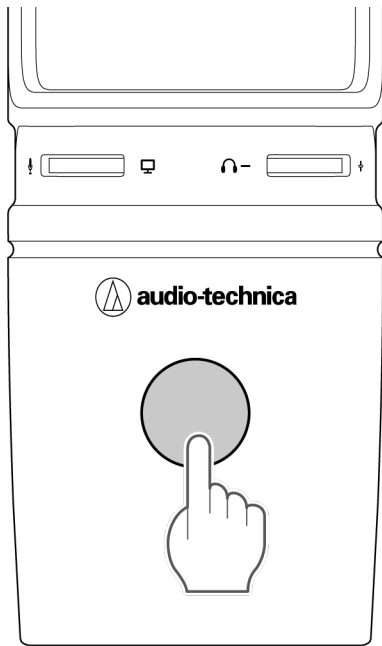

Automatic gain control

This auxiliary function is used to correct the gain automatically and prevent distortion of the output when the input signal is excessive. This function optimizes microphone gain setting automatically.

1 Press the automatic gain control button.

- When the automatic gain control button is pressed, the automatic gain control indicator lamp lights and turns the function on.

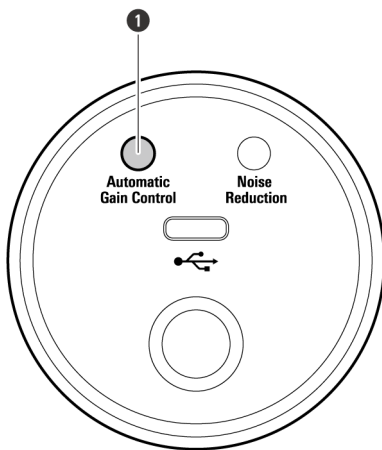

1 Automatic gain control button

Caution

- Automatic gain control is available only when the sampling frequency is 44.1 kHz, 48 kHz, 88.2 kHz, or 96 kHz. If the sampling frequency is set to a sampling frequency that cannot be used, the Automatic gain control indicator lamp will blink three times and turn off (indicating an error). Set to a supported sampling frequency.

Noise-reduction

This function reduces the constant ambient noise.

1 Press the noise-reduction button.

- Each time you press the button, the function level increases and the noise reduction indicator lamp lights in three levels.
- For best sound quality, use the least amount of noise-reduction function required for your environment.

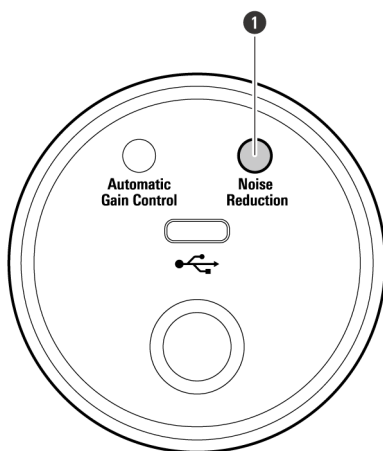

1 Noise-reduction button

Caution

- If your software has a noise-reduction function, it may affect the audio when used in combination with the noise-reduction function of the product. In this case, turn off either noise-reduction function.
- Noise-reduction is available only when the sampling frequency is 44.1 kHz or 48 kHz. If the sampling frequency is set to a sampling frequency that cannot be used, the noise-reduction indicator lamp will blink three times and the light turn off (indicating an error). Set to a supported sampling frequency.

Cleaning

Get into the habit of regularly cleaning the product to ensure that it will last for a long time. Do not use alcohol, paint thinners, or other solvents for cleaning purposes.

- Wipe dirt off the product with a dry cloth.
- If the cables become dirty because of sweat, etc., wipe them with a dry cloth immediately after use. Failure to clean the cables may cause them to deteriorate and harden over time, resulting in a malfunction.

Caution

- If the product will not be used for an extended period of time, store it in a well-ventilated place free from high temperatures and humidity.
-

Troubleshooting

? The mute indicator lamp is blinking

- The sampling rate setting differs from that set in the "Playback" or "Recording" tab on the Windows PC you are using or in the "Output" or "Input" tab on the Mac you are using. Match the sampling rate settings. For details on the settings, refer to "Computer settings (Windows)" (p. 10) or "Computer settings (macOS)" (p. 35).

? Automatic gain control does not work

- Automatic gain control is available only when the sampling frequency is 44.1 kHz, 48 kHz, 88.2 kHz, or 96 kHz. If the sampling frequency is set to a sampling frequency that cannot be used, the Automatic gain control indicator lamp will blink three times and turn off (indicating an error). Set to a supported sampling frequency.

? Noise-reduction does not work

- Noise-reduction is available only when the sampling frequency is 44.1 kHz or 48 kHz. If the sampling frequency is set to a sampling frequency that cannot be used, the noise-reduction indicator lamp will blink three times and the light turn off (indicating an error). Set to a supported sampling frequency.

? The product is not recognized

- Check that the USB cable is properly connected.
- If a USB hub or similar device is used, disconnect it. Connect the product directly to the PC with a USB cable.
- Check the compatible OS.
- The product may not operate correctly depending on the computer you are using. Countermeasures for these situations are provided on the Audio-Technica website.

? No sound is produced

- Check that the mute is on.
- The product may not operate correctly depending on the computer you are using. Countermeasures for these situations are provided on the Audio-Technica website.

? Sound is distorted

- Lower the audio input level of the microphone to prevent distortion. For details on the settings, refer to "Computer settings (Windows)" (p. 10) or "Computer settings (macOS)" (p. 35).
- The product may not operate correctly depending on the computer you are using. Countermeasures for these situations are provided on the Audio-Technica website.

? Recorded audio is played back at twice the normal speed

- The sampling rate setting differs from that set in the "Playback" or "Recording" tab on the Windows PC you are using or in the "Output" or "Input" tab on the Mac you are using. Match the sampling rate settings. For details on the settings, refer to "Computer settings (Windows)" (p. 10) or "Computer settings (macOS)" (p. 35).
- The product may not operate correctly depending on the computer you are using. Countermeasures for these situations are provided on the Audio-Technica website.

Supported bit depths and sampling rates

The product supports the following bit depths and sampling rates.

Recording (output)	Playback (input)
1 channel, 16 bit, 44100 Hz	2 channel, 16 bit, 44100 Hz
1 channel, 16 bit, 48000 Hz	2 channel, 16 bit, 48000 Hz
1 channel, 16 bit, 88200 Hz ^[2]	2 channel, 16 bit, 88200 Hz ^[2]
1 channel, 16 bit, 96000 Hz ^[2]	2 channel, 16 bit, 96000 Hz ^[2]
1 channel, 16 bit, 192000 Hz ^{[1][2]}	2 channel, 16 bit, 192000 Hz ^{[1][2]}
1 channel, 24 bit, 44100 Hz	2 channel, 24 bit, 44100 Hz
1 channel, 24 bit, 48000 Hz	2 channel, 24 bit, 48000 Hz
1 channel, 24 bit, 88200 Hz ^[2]	2 channel, 24 bit, 88200 Hz ^[2]
1 channel, 24 bit, 96000 Hz ^[2]	2 channel, 24 bit, 96000 Hz ^[2]
1 channel, 24 bit, 192000 Hz ^{[1][2]}	-

[1] Automatic gain control is not available.

[2] Noise-reduction is not available.

Limitations of the automatic gain control

Automatic gain control is available only when the sampling frequency is 44.1 kHz, 48 kHz, 88.2 kHz, or 96 kHz. If the sampling frequency is set to a sampling frequency that cannot be used, the Automatic gain control indicator lamp will blink three times and turn off (indicating an error). Set to a supported sampling frequency.

Limitations of Noise-reduction

Noise-reduction is available only when the sampling frequency is 44.1 kHz or 48 kHz. If the sampling frequency is set to a sampling frequency that cannot be used, the noise-reduction indicator lamp will blink three times and the light turn off (indicating an error). Set to a supported sampling frequency.

Note

- Playback at 24-bit, 192 kHz is not supported.

Dimensions

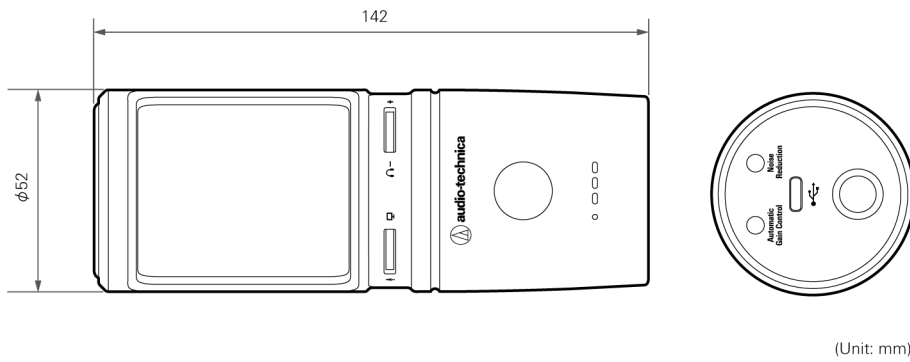

(Unit: mm)

Specifications

System requirements	USB 2.0 compliant
Supported OS	Windows 10, Windows 11 macOS Catalina, macOS Big Sur, macOS Monterey, macOS Ventura (Please check the product's web page for the latest information.)
Element	Fixed-charge back plate, permanently polarized condenser
Polar pattern	Cardioid
Frequency response	20-20,000 Hz
Power supply	USB power (5 VDC)
Bit depth	16 bit/24 bit
Supported sampling rates	44.1 kHz/48 kHz/88.2 kHz/96 kHz/192kHz ^[1]
Controls	Headphone level control, Mix control, Mute, Auto gain control, Noise-reduction
Dimensions	142 mm (5.6") long, 52 mm (2.0") maximum body diameter
Weight	About 375 g (13 oz)
Output connector	USB Type-C
Headphone output	110 mW (at 1 kHz, 1% T.H.D., 32 ohms)
Headphone jack	3.5 mm (1/8") stereo mini-jack
Included accessories	Stand (AT8702), Pop filter (AT8175 / AT8155 ^[2]), 3/8"-16 to 5/8"-27 threaded adapter, USB cable (about 2.0 m (6.6')), USB Type-C to USB Type-A), USB conversion adapter (USB Type-A to USB Type-C)

[1] Playback at 24-bit and 192 kHz is not supported.

[2] Available only in the United States.



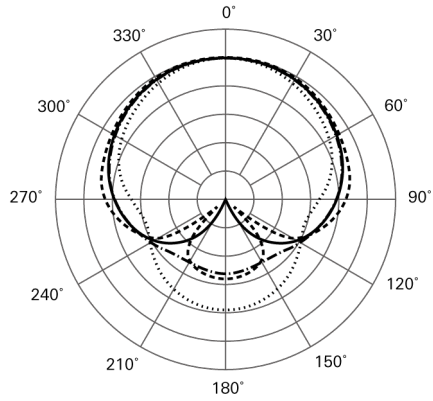

- For product improvement, the product is subject to modification without notice.

Polar pattern / Frequency response

Polar pattern

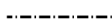

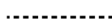
LEGEND

	200 Hz	SCALE IS 5 DECIBELS PER DIVISION
	1 kHz	
	5 kHz	
	8 kHz	

Frequency response

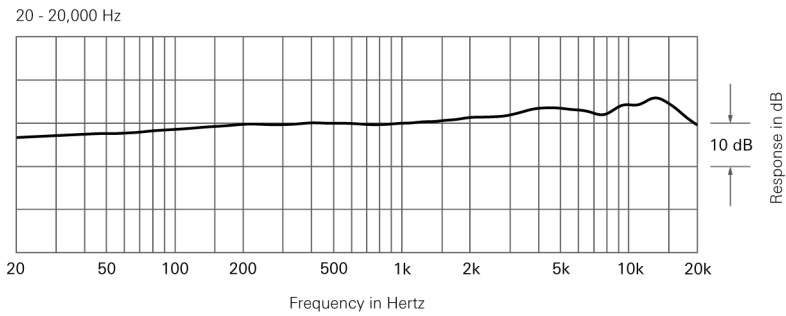

LEGEND

	0°, 50cm
---	----------

Trademarks

- USB Type-C™ is a trademark of USB Implementers Forum.
- Microsoft® and Windows® are registered trademarks of Microsoft Corporation in the United States and/or other countries.
- Microsoft Windows operating system is indicated in its abbreviated form as Windows.
- Mac and macOS are trademarks of Apple Inc., registered in the U.S. and other countries and regions.

株式会社オーディオテクニカ

〒194-8666 東京都町田市西成瀬2-46-1
www.audio-technica.co.jp

Audio-Technica Corporation

2-46-1 Nishi-naruse, Machida, Tokyo 194-8666, Japan
www.audio-technica.com
©2023 Audio-Technica Corporation
Global Support Contact: www.at-globalsupport.com