

TASCAM

D01418720A

FR-AV2

Linear PCM Recorder

Owner's Manual

V1.00

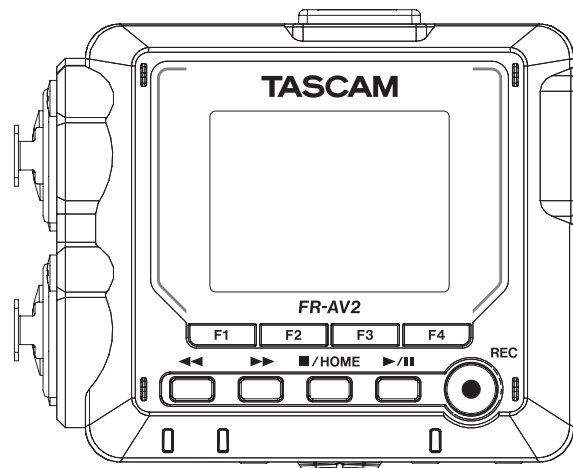

Contents

1. Introduction	5	4-5. Basic operation	22
1-1. Included items	5	Setting item selection procedures	22
1-2. Features	5	Sliders	22
1-3. Conventions used in this manual	6	Slider switches	22
1-4. Trademarks and copyrights	6	Character input	23
1-5. Using microSD cards	7	Pop-ups	23
Precautions for use	7	5. Connections	24
Note about formatting	7	5-1. Connection example	24
1-6. Accessories sold separately	7	5-2. Connecting external mics and other equipment	24
USB cables (for communication and data transmission)	7	Connecting external mics	24
Using a PS-P520U AC adapter	7	Connecting mics that require plug-in power	25
AK-BT2 Bluetooth® adapter overview	7	Connecting mid-side mics	25
Batteries	7	Connecting other equipment	25
2. Quick Start Guide	8	5-3. Connecting cameras	26
2-1. Inserting microSD cards	8	Setting output for camera use	26
2-2. Installing batteries	8	5-4. Connecting monitoring equipment	26
2-3. Connecting external mics	8	5-5. Adjusting the headphone output volume	27
2-4. Turning the power on	9	5-6. Connecting computers and smartphones	27
2-5. Setting the date and time	9	5-7. Synchronizing with timecode	28
2-6. Formatting (initializing) microSD cards	9	Receiving timecode	28
2-7. HOME screen	10	Transmitting timecode	28
2-8. Adjusting the recording level (REC LEVEL)	10	Timecode connection examples	29
2-9. Recording	10	6. Input and output settings	30
2-10. Playing recorded files	10	6-1. Making input settings for each input	30
2-11. Listening to sound with headphones	11	Adjusting the recording level (REC LEVEL)	30
2-12. Listening with earphones or speakers that support Bluetooth	11	Setting the GANG operation mode (GANG)	30
2-13. Using timecode	12	Setting channels to record (REC ENABLE)	31
2-14. Turning the unit off (putting it in standby)	13	Setting recording input sources (INPUT)	31
3. Names and functions of parts	14	Stereo linking (STEREO LINK)	31
3-1. Top	14	Using phantom power (PHANTOM)	31
3-2. Bottom	14	Setting plug-in power (PLUG IN POWER)	31
3-3. Left side	15	Compensating for mic distances (DELAY)	31
3-4. Right side	15	Setting the low-cut filter (LOW CUT)	31
3-5. Front panel	15	Setting the limiter (DYNAMICS)	31
3-6. Rear panel	15	Setting the equalizer (EQ)	32
4. Preparation	16	Setting the noise gate (NOISE GATE)	32
4-1. Inserting and removing microSD cards	16	Inverting the input phase (PHASE INVERT)	32
Inserting microSD cards	16	6-2. Setting the phantom power voltage	33
Removing microSD cards	16	6-3. Using the mid-side decoding function	34
4-2. Preparing the power supply	16	Connection settings	34
Notes about power supplies	16	Adjusting mid and side levels	34
Using AA batteries	16	6-4. Adjusting the volume	35
Using an AC adapter (sold separately)	17	GANG operation	35
Using USB bus power	17	Output sound (OUTPUT)	35
4-3. Turning the unit on and off	18	Adjusting mid and side levels (MS WIDE)	35
Turning the power on	18	LIMITER	35
Turning the unit off (putting it in standby)	18	DELAY	35
Resume function	18	6-5. Saving and recalling input settings	36
Set the date and time	18	Saving presets	36
Formatting (initializing) microSD cards	19	Loading presets	37
4-4. HOME screen	20	7. Recording	38
Icon	20	7-1. Overview of recording	38
When recording/playback stopped	20	Recording pause/standby function (REC PAUSE MODE)	38
When recording, in recording standby or recording paused	21	Recording hold function (REC HOLD)	38
When playing, paused or searching forward/backward	21	Recording operation flow	38
		7-2. Button operations during recording	39

8. Recording settings	40	12. Camera functions.....	51
8-1. Monitoring individual inputs (SOLO).....	40	12-1. Setting output for camera use.....	51
8-2. Changing the recording file format	40	12-2. Using the automatic tone function (SLATE TONE •	
8-3. Pausing when recording (REC PAUSE MODE)	40	AUTO)	51
8-4. Capturing sound before recording starts (PRE REC)..	40	Auto tone function (AUTO).....	51
8-5. Recording file naming.....	41	Tone volume adjustment function (LEVEL)	51
8-6. Designating the folder used for recordings.....	41	Oscillator function (OSCILLATOR).....	51
8-7. Changing files while continuing to record (file		13-1. Connecting with computers.....	52
incrementation function).....	41	13-2. Connecting with iOS devices	52
8-8. Recording times (in hours: minutes)	41	13-3. Accessing microSD cards from a computer.....	52
9. Playing files	42	Exchanging files with computers.....	52
9-1. Open the playback screen.....	42	13-4. Using the ASIO driver	52
Screen overview.....	42	13. USB connection	52
Playing and pausing.....	42	13-5. Using as an audio interface.....	53
Stopping playback	42	FR-AV2 USB audio channel assignments.....	53
Moving the playback position (searching backward/		Inputting sound to the computer using the unit	
forward).....	42	inputs.....	53
Selecting files for playback.....	42	Using the computer output as sound input to this	
Seeking backward and forward momentarily	42	unit	53
10. File operations	43	14. Remote control functions.....	54
10-1. File name overview	43	14-1. Installing the dedicated controller app.....	54
Changing how files are named.....	43	14-2. Connecting with this unit using Bluetooth	54
Setting the file number	44	14-3. Connecting with the dedicated control app.....	55
10-2. File and project structure overview	44	14-4. Wireless timecode synchronization with supported	
Folders.....	44	Atomos products	55
Recording data.....	44	Connecting with supported Atomos products.....	55
10-3. Folder hierarchy example	44	15. Timecode functions	57
10-4. Project overview	45	15-1. TIMECODE selection	57
10-5. Using the BROWSE screen.....	45	TC GEN MODE.....	57
10-6. Folder operations	46	COUNTER VIEW.....	57
Screen overview.....	46	Receiving timecode by wire.....	57
Moving between folders.....	46	Receiving timecode by Bluetooth.....	57
Quick file playback	46	Outputting timecode.....	58
Folder menu	46	TIMECODE INFORMATION.....	58
Creating folders (NEW FOLDER)	47	FREE RUN	58
Changing the names of folders (RENAME)	47	16. Wireless audio monitoring functions.....	59
Deleting all files in a folder (ALL FILES DELETE).....	47	16-1. Wireless audio monitoring	59
Deleting folders (FOLDER DELETE)	47	Pairing	59
10-7. File and project operations	48	Connecting with already paired devices.....	59
File menu	48	Deleting pairing data	60
Selection (SELECT)	48	Quality settings (QUALITY).....	60
Deleting projects (FILE DELETE)	48	17. Various settings	61
Changing names (RENAME).....	48	17-1. Showing various information.....	61
Enabling and disabling protection		17-2. Resetting the date and time	61
(CHANGE PROTECT)	48	17-3. Resetting the unit to its factory defaults.....	61
File information (FILE INFORMATION).....	48	17-4. Formatting microSD cards.....	61
Viewing mark lists (MARK)	49	17-5. Using the automatic power saving function.....	61
Deleting marks	49	17-6. Selecting the power source	61
10-8. Setting where recording projects are saved	49	17-7. Setting the AA battery type (BATTERY).....	61
11. Mark functions	50	17-8. Saving and recalling user settings	61
11-1. Mark types.....	50	17-9. Power saving (energy conservation) mode.....	62
11-2. Adding marks.....	50	17-10. Adjusting the display contrast (CONTRAST)	62
Adding marks automatically (TIME MARK).....	50	17-11. MENU	63
Adding marks when peak levels occur (PEAK MARK) ..		17-12. BROWSE.....	64
50		17-13. INPUT SETTINGS	65
Adding marks manually	50	MANUAL EQ.....	65
11-3. Deleting marks	50	17-14. OUTPUT SETTINGS.....	65
Deleting all marks	50	18. Messages	66
11-4. Jumping to set marks (MARK SKIP MODE).....	50	19. Troubleshooting.....	67
11-5. Opening the mark list	50		

Contents

20. Specifications	69
20-1. Specifications and rated values	69
Recorder specifications	69
Analog audio input ratings	69
Analog audio output ratings	69
USB	69
USB Audio	69
Timecode input/output	69
Bluetooth device connector	69
Audio performance	70
Recording times (in hours: minutes)	70
Operating system and other requirements	70
Other	71
20-2. Dimensional drawings	71

Thank you very much for purchasing the TASCAM FR-AV2. Before using this unit, read this Owner's Manual carefully so that you will be able to use it correctly and enjoy working with it for many years. After you have finished reading this manual, please keep it in a safe place for future reference. You can also download this Owner's Manual from the TASCAM website.



FR-AV2

<https://tascam.jp/int/product/fr-av2/docs>

1-1. Included items

This product includes the following items.

Take care when opening the package to avoid damaging the items. Keep the box and packing materials for transportation in the future.



Please contact the store where you purchased this unit if any of these items are missing or have been damaged during transportation.

Main unit × 1

Safety Guide (with warranty) × 1

TASCAM ID registration guide × 1

1-2. Features

- A 2.0-inch color screen makes the interface easy to view.
- With 2 lockable XLR input jacks, recording with multiple mic/line inputs is possible. Each channel has individual phantom power supply (24 V/48 V) support.
- Recording is supported with resolutions up to 192 kHz/32-bit float (floating-point arithmetic). This enables audio editing using DAW software without reducing the audio quality of the recorded data.
- USB audio interface function supports 2 ins and 2 outs.
- Up to 5 of these recorders can be controlled and monitored using the TASCAM RECORDER CONNECT remote control app by installing AK-BT2 Bluetooth® adapter (sold separately) in them. ¹ Moreover, wireless timecode synchronization with products made by Atomos is supported.
- Input sounds can be monitored and playback sounds can be listened to wirelessly if an AK-BT2 Bluetooth adapter (sold separately) is installed. ²
- Numerous available functions include low-cut filter, compressor, limiter and noise gate.
- /EXT/TC IN jack built in. This supports recorded sound output from a camera, sound output from wireless mics and plug-in power mics and other sources.
- The /LINE/TC OUT jack has an attenuation function and allows audio output to cameras and other devices.
- Audio can be monitored using the headphone output or wirelessly over Bluetooth using an AK-BT2 (sold separately).
- Supports microSD, microSDHC and microSDXC (up to 512 GB) recording media.
- Equipped with a USB Type-C port that supports USB bus power. Supports operation on USB bus power.
- Recording is possible for at least 9 hours using 3 AA batteries. ³
- Various mark functions and an automatic slate tone function are available.
- Supports capturing metadata (WAV file BEXT and iXML) when recording

1. The number of recorders that can be connected could vary depending on the surrounding environment and radio wave conditions.

2. Either remote control or wireless timecode synchronization is also possible using an AK-BT1.

3. The battery operation time could vary depending on the settings and the batteries and media being used.

1-3. Conventions used in this manual

We use the following conventions in this manual.

- “microSD/microSDHC/microSDXC memory card” is sometimes abbreviated as “microSD card”.
- Smartphones, tablets and other devices connected to this unit using Bluetooth are called “Bluetooth devices”.
- Files created during a single recording are referred to collectively as a project.
- The project that is currently selected is called the “current project”.
- Information shown on a computer display is written like this: “OK”.
- References to “iOS” in this document also include “iPad OS”.
- As necessary, additional information is provided under TIP, NOTE and CAUTION headings.

TIP

These are tips about how to use the unit.

NOTE

These provide additional explanations and describe special cases.

CAUTION

Failure to follow these instructions could result in damage to equipment or lost data, for example.

⚠ CAUTION

Failure to follow these instructions could result in injury.

1-4. Trademarks and copyrights

- TASCAM is a registered trademark of TEAC Corporation.
- microSDXC Logo is a trademark of SD-3C, LLC.



- MPEG Layer-3 audio coding technology licensed from Fraunhofer IIS and Thomson.
- Supply of this product does not convey a license nor imply any right to distribute MPEG Layer-3 compliant content created with this product in revenue-generating broadcast systems (terrestrial, satellite, cable and/or other distribution channels), streaming applications (via Internet, intranets and/or other networks), other content distribution systems (pay-audio or audio-on-demand applications and the like) or on physical media (compact discs, digital versatile discs, semiconductor chips, hard drives, memory cards and the like). An independent license for such use is required. For details, please visit <http://mp3licensing.com>.
- Microsoft and Windows are either registered trademarks or trademarks of Microsoft Corporation in the United States and/or other countries.
- Apple, Mac, macOS, iOS, iPad, iPadOS and iTunes are trademarks of Apple Inc. in the United States and other countries. The iPhone trademark is used under license from Aiphone Co., Ltd.
- App Store is a service mark of Apple Inc.
- Lightning is a trademark of Apple Inc.
- IOS is a trademark or registered trademark of Cisco in the U.S. and other countries and is used under license.
- Android and Google are trademarks of Google LLC.
- The Bluetooth® word mark and logo are the property of Bluetooth SIG, Inc. and are used by TEAC Corporation with permission.
- ASIO is a trademark and software of Steinberg Media Technologies GmbH.



- Other company names, product names and logos in this document are the trademarks or registered trademarks of their respective owners.

Information is given about products in this manual only for the purpose of example and does not indicate any guarantees against infringements of third-party intellectual property rights and other rights related to them. TEAC Corporation will bear no responsibility for infringements on third-party intellectual property rights or their occurrence because of the use of these products.

Properties copyrighted by third parties cannot be used for any purpose other than personal enjoyment and the like without the permission of the right holders recognized by copyright law. Always use this equipment properly. TEAC Corporation will bear no responsibility for rights infringements committed by users of this product.

1-5. Using microSD cards

A microSD card is necessary to record and play files with this unit. Prepare one for use.

This unit can use microSD cards that are Class 10 or higher and compatible with microSD, microSDHC or microSDXC standards. A list of microSD cards that have been confirmed for use with this unit can be found on the TASCAM website. You can also contact TASCAM customer support.

<https://tascam.jp/int/product/fr-av2/docs>

Precautions for use

microSD cards are delicate media.

In order to avoid damaging microSD cards, take the following precautions when handling them.

- Do not leave them in extremely hot or cold places.
- Do not leave them in extremely humid places.
- Do not let them get wet.
- Do not put things on top of them or twist them.
- Do not hit them.
- Do not remove or insert them during recording, playback, data transmission or other access.
- Always put memory cards in cases when transporting them.

Note about formatting

microSD cards formatted by this unit are optimized to improve performance during recording. Use this unit to format the microSD cards to be used with it. Errors might occur when recording with this unit using a microSD card formatted by a computer or other device.

1-6. Accessories sold separately

This product does not include the following items.

Please purchase any that you need for your uses.

USB cables (for communication and data transmission)

A USB cable must be prepared to connect this unit to a computer (Windows/Mac) or smartphone. (We recommend a product that is USB-IF certified.)

This unit has a USB Type-C port.

Prepare a USB cable suitable for the USB port of the computer or smartphone being used.

- USB cables designed only for charging cannot be used.

Connecting to an iOS device with a lightning port

A genuine Apple Lightning to USB Camera Adapter and a commercially-available Type-A to Type-C cable are necessary.

Connecting to a computer or smartphone with a USB Type-C port

A commercially-available Type-C to Type-C cable is necessary.

Connecting to a smartphone with a USB micro-B port

A commercially-available micro-B to Type-C cable is necessary.

Connecting to a computer with a USB Type-A port

A commercially-available Type-A to Type-C cable is necessary.

Using a PS-P520U AC adapter

This is necessary to operate this unit using AC power.

NOTE

This unit does not have a battery charging function when using an AC adapter.

AK-BT2 Bluetooth® adapter overview

Installing an AK-BT2 in this unit enables timecode synchronization with products made by Atomos as well as wireless remote control using smartphones and tablets.¹

In addition, using this adapter, input sounds can be monitored and playback sounds can be listened to wirelessly by connecting Bluetooth headphones or speakers.

1. The TASCAM RECORDER CONNECT remote control app can be used to simultaneously control and monitor up to 5 of these recorders.

Batteries

To power this unit with batteries, prepare three batteries. Alkaline, Ni-MH or lithium AA batteries can be used.

2. Quick Start Guide

This section explains how to supply power with batteries, connect XLR mics to the unit, record and play recordings.

2-1. Inserting microSD cards

Insert a microSD card into the microSD card slot on the right side to enable playback and recording by this unit.

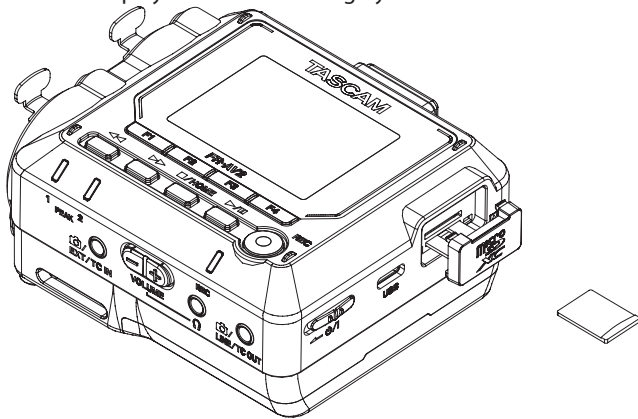

2-2. Installing batteries

Install 3 AA batteries in the battery compartment.

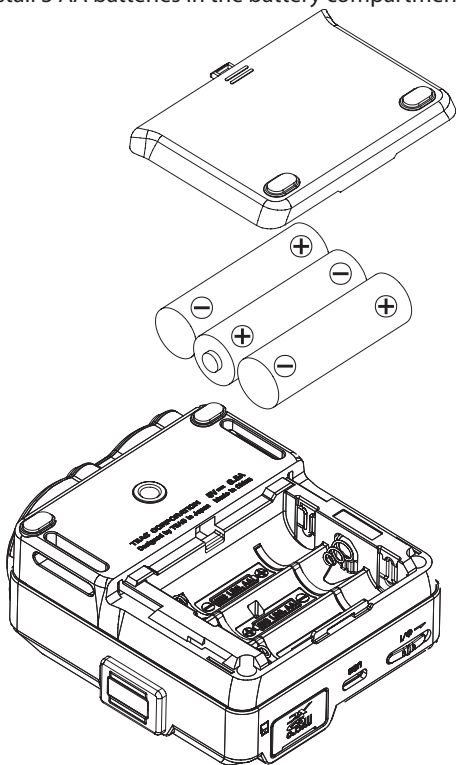

Set the type of batteries used for batteries other than alkaline.
("Setting the AA battery type (BATTERY)" on page 61)

2-3. Connecting external mics

Connect one or two mics to the unit.

Example connecting to input jacks 1-2

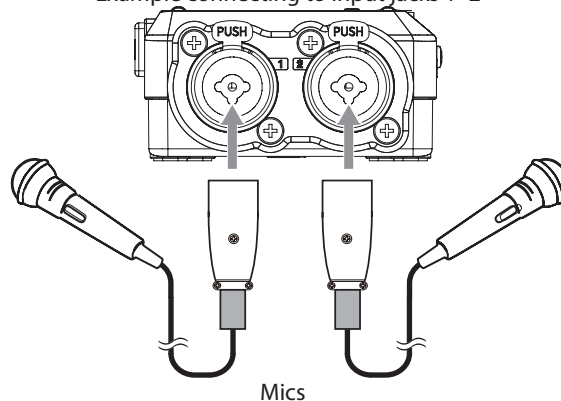

2-4. Turning the power on

Slide the O/I switch toward \leftarrow until the display is activated. Then, release the switch.



Start up screen

2-5. Setting the date and time

Whenever the date and time have been reset, the DATE/TIME screen will open to enable setting them.

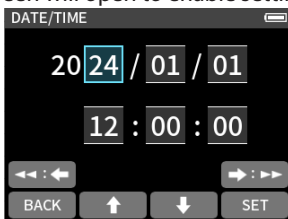

- Use the F2 [\uparrow] and F3 [\downarrow] buttons to change the values
- Use the \leftarrow [\leftarrow] and \rightarrow [\rightarrow] buttons to move the cursor
- Press the F4 [SET] button to confirm

2-6. Formatting (initializing) microSD cards

The following message will appear if an unformatted card is loaded.

Press the F4 [OK] button to start formatting.

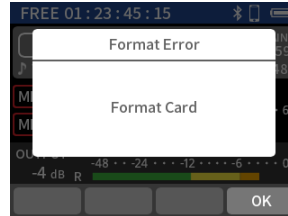

1. Select "QUICK FORMAT" or "FULL ERASE FORMAT".

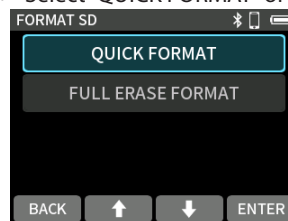

2. Press the F4 [YES] button.

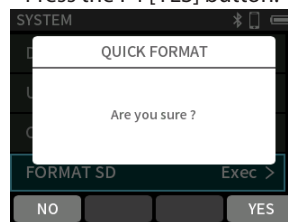

CAUTION

Formatting will erase all data on a microSD card.

2-7. HOME screen

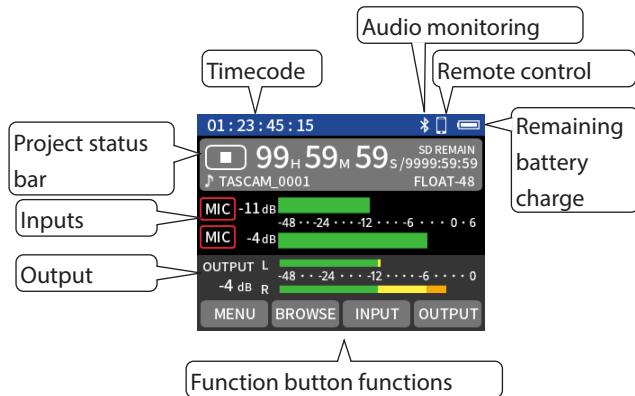

NOTE

- For details about the HOME screen, see “HOME screen” on page 20.
- See “Basic operation” on page 22 for setting screen operation procedures.

2-8. Adjusting the recording level (REC LEVEL)

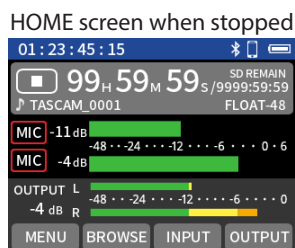

Press the F3 [INPUT] button.

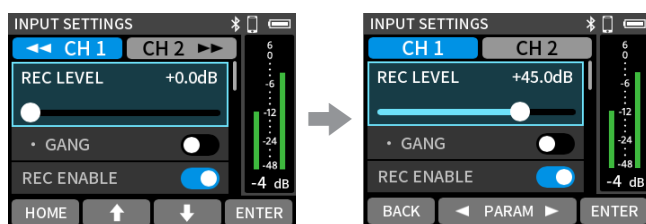

Select REC LEVEL and press the F4 [ENTER] button.

Use the F2 [◀ PARAM] and F3 [PARAM ▶] buttons to adjust it.

- When stereo linking is off, use the ◀◀ and ▶▶ buttons to select the channel to set.

NOTE

- Make phantom power settings when using a mic that requires phantom power. (“Setting the phantom power voltage” on page 33)
- See “Making input settings for each input” on page 30 for details about the settings for each input.
- See “Recording settings” on page 40 for details about recording settings.

2-9. Recording

1. Press the REC [●] button to start recording.



2. Press and hold the ■/HOME button to stop recording.



NOTE

See “Overview of recording” on page 38 for details about recording operations.

2-10. Playing recorded files

1. When stopped or paused, press the ▶/II button to start playback.

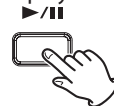

2. During playback, press the ■/HOME button to stop playback.



NOTE

See “Playing files” on page 42 and “File operations” on page 43 for details about playback operations.

2-11. Listening to sound with headphones

1. Connect headphones with a 3.5 mm (1/8") stereo mini plug.

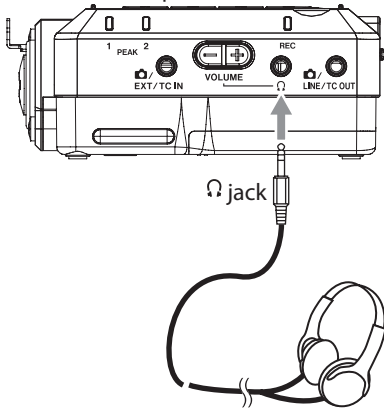

CAUTION

While wearing headphones, do not connect or disconnect the headphone plug or turn the unit on or put it into standby. Doing so might cause sudden loud noises, which could harm hearing.

Always set the volume to minimum (0) before putting headphones on.

2. Press the Ω (headphone) volume +/- to adjust the volume.

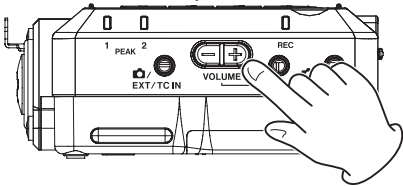

2-12. Listening with earphones or speakers that support Bluetooth

Enable Bluetooth transmission on the earphone, speaker or other device that supports Bluetooth, and make the MENU > Bluetooth setting to connect this device.

1. AUDIO MONITORING: ON

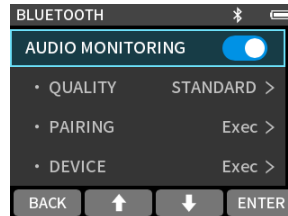

2. Pairing

BLUETOOTH screen

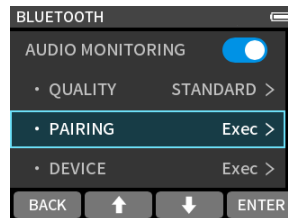

Select PAIRING and press the F4 [ENTER] button.

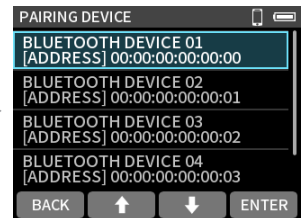

Select the device to connect and press the F4 [ENTER] button.

- When connecting a device that is already paired, select it from the DEVICE list.

3. After connecting, press the headphone volume +/- to adjust the volume.

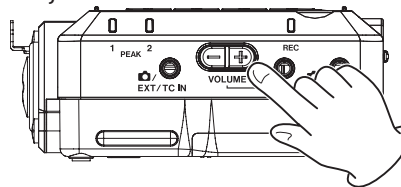

See "Wireless audio monitoring" on page 59 for details.

2-13. Using timecode

Make the following settings on the MENU > TIMECODE setting screen

When receiving timecode by wire

1.

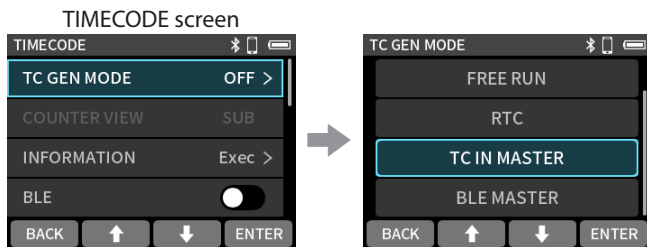

Select TC GEN MODE and press the F4 [ENTER] button.

Select TC IN MASTER and press the F4 [ENTER] button.

2.

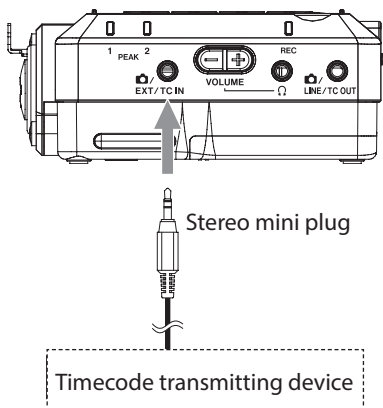

When outputting timecode by wire

1.

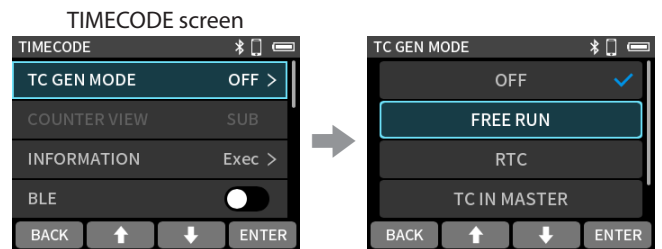

Select TC GEN MODE and press the F4 [ENTER] button.

Select any setting other than "OFF" and press the F4 [ENTER] button.

2.

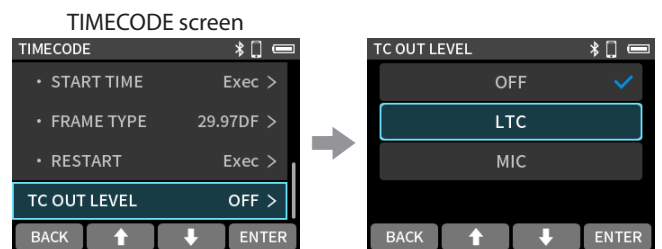

Select TC OUT LEVEL and press the F4 [ENTER] button.

Select "LTC" or "MIC" and press the F4 [ENTER] button.

Select the "TC OUT LEVEL" setting according to the input specifications of the device receiving the timecode.

3.

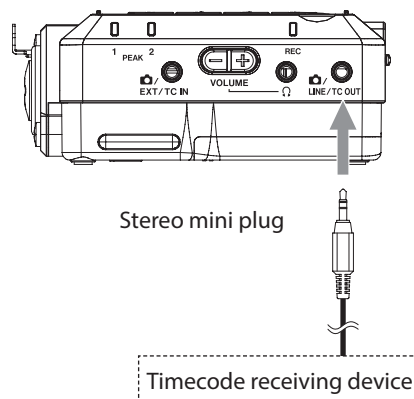

See "Timecode functions" on page 57 for details.

When receiving timecode by Bluetooth

1.

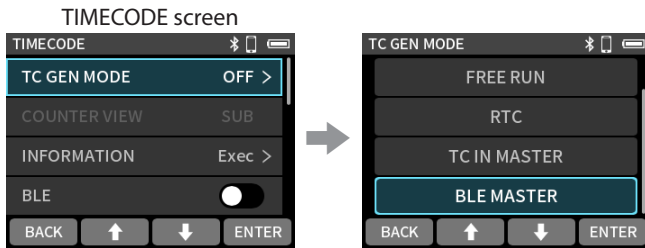

Select TC GEN MODE and press the F4 [ENTER] button.

Select BLE MASTER and press the F4 [ENTER] button.

2. Turn on TIMECODE > BLE.

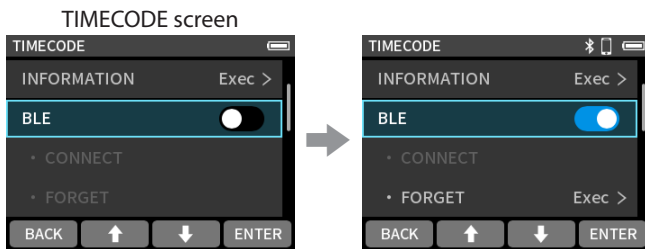

Press the F4 [ENTER] button.

3. Select BLE • CONNECT and press ENTER to pair.

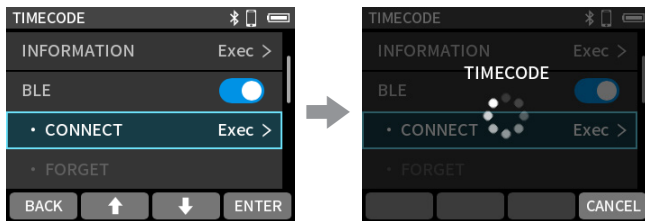

Select BLE • CONNECT and press the F4 [ENTER] button.

After pairing completes, "CONNECT" will appear dimmed.

For details, see "14-4 Wireless timecode synchronization with supported Atomos products" on page 44.

2-14. Turning the unit off (putting it in standby)

Slide the switch toward until the display turns off. Then, release the switch.

3. Names and functions of parts

3-1. Top

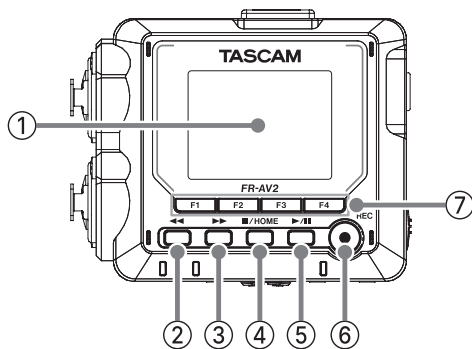

① Display

This shows a variety of information.

② ◀◀ button

Press this when playing or stopped to search backward.
Press this when searching backward to increase the search speed.
Press this when searching forward to decrease the search speed.
Press and hold this when playing, stopped or searching backward to seek backward.

③ ▶▶ button

Press this when playing or stopped to search forward.
Press this when searching forward to increase the search speed.
Press this when searching backward to decrease the search speed.
Press and hold this when playing, stopped or searching forward to seek forward.

④ ■ /HOME button

Press this during playback to stop playback and set the playback position to the beginning of that file.
Press this when recording or in recording standby to stop recording.
Press when any screen other than the HOME screen is open to return to the HOME screen.

⑤ ▶ /|| button

Press this when stopped to start playback.
Press during playback to pause.
Press this when a file is selected on the BROWSE screen to play that file.
Press this when recording to put the unit in recording standby.
The function changes according to the REC PAUSE MODE setting. See "Recording operation flow" on page 38 for details.

⑥ REC [●] button

Press this when stopped to start recording.

⑦ Function buttons (F1, F2, F3, F4)

The function assigned to each button changes according to the screen shown on the display.
Icons for the currently assigned functions are shown at the bottom of the display.
Unless TC GEN MODE is "OFF", pressing and holding the F4 button changes the COUNTER VIEW setting, switching the positions of the counter and timecode on the HOME screen.

3-2. Bottom

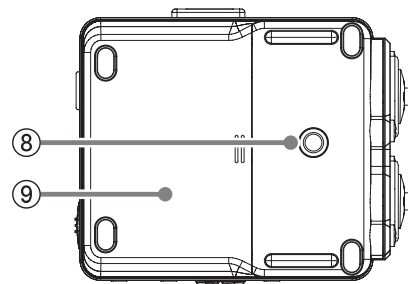

⑧ Tripod mounting threads (1/4-inch)

Use this to attach this unit to a tripod.

CAUTION

- Ensure the tripod or mic stand screw is securely fastened to prevent the unit from falling.
- When attaching this unit to a tripod or mic stand, be sure to place it on a level surface.
- Some tripods have different screw specifications that make direct connection impossible. Use a commercially-available adapter with such tripods.
- Screws that are longer than 4.5 mm cannot be used for attachment.

⑨ Battery compartment (AA batteries)

Install 3 AA batteries in this compartment to power the unit.

3-3. Left side

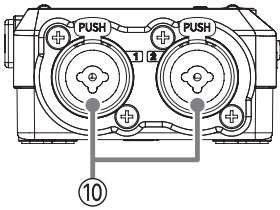

⑩ Input jacks 1/2 (Inputs 1/2)

These balanced analog input combine XLR mic and standard TRS jacks.

XLR (1: GND, 2: HOT, 3: COLD)

TRS (Tip: HOT, Ring: COLD, Sleeve: GND)

3-4. Right side

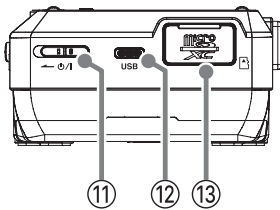

⑪ \mathcal{P} /I switch

Slide this switch toward the \mathcal{P} icon to turn the unit on and off (put it into standby).

CAUTION

Before turning the unit on, lower the volumes of connected equipment to their minimum levels.

Failure to do so might cause sudden loud noises, which could harm hearing or result in other trouble.

⑫ USB Type-C port

This is a Type-C USB port.

Use a commercially-available USB cable to connect a computer or smartphone. ("Connecting computers and smartphones" on page 27)

When using an AC adapter, connect it to this port. ("Using an AC adapter (sold separately)" on page 17)

⑬ microSD card slot

Insert microSD cards into this slot.

3-5. Front panel

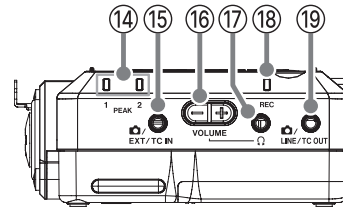

⑭ PEAK 1/2 indicators

This lights when the input level exceeds the peak level.

⑮ \mathcal{C} /EXT/TC IN jack

Use a stereo mini jack cable to connect this to the line output jack of an audio device, for example, an external mic (3.5 mm TRS) that supports plug-in power, or a timecode transmitting device.

⑯ Ω (headphone) volume

Use this to adjust the volume output from the Ω (headphone) jack and for wireless audio monitoring.

⑰ Ω (headphone) jack

Connect headphones to this jack.

⑱ REC indicator

This blinks when in recording standby and lights when recording.

⑲ \mathcal{C} /LINE/TC OUT jack

Use a stereo mini jack cable to connect this with the line input jack of another device or with a device receiving timecode.

3-6. Rear panel

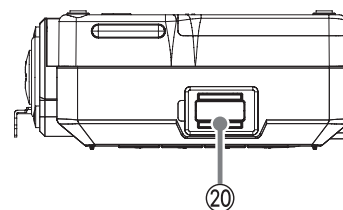

⑳ Bluetooth adapter connector

Connect a dedicated Bluetooth adapter (AK-BT2, sold separately) here.

4. Preparation

4-1. Inserting and removing microSD cards

Inserting microSD cards

Insert a microSD card into the microSD card slot on the right side to enable playback and recording by this unit.

NOTE

microSD cards can be inserted when the unit is on or off.

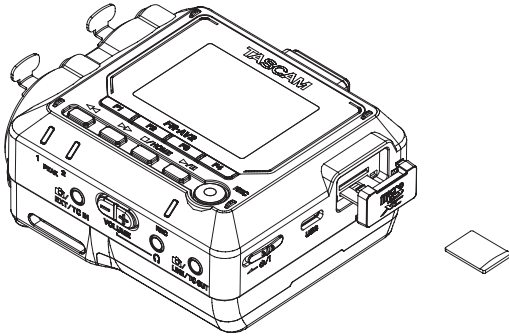

1. Open the microSD slot cover.
2. Insert the microSD card label side up.
3. Close the microSD slot cover.

Removing microSD cards

Turn the unit off or stop operation before removing a microSD card.

CAUTION

Never remove a microSD card when the unit is operating (including recording, playing back, or writing data to the microSD card). Doing so could cause proper recording to fail, data to be lost, and sudden loud noises from monitoring equipment, which might damage the equipment, harm hearing or cause other trouble.

1. Press the microSD card in gently and then release it. It will start to come out.
2. Pull the microSD card out.

4-2. Preparing the power supply

Notes about power supplies

This unit can be powered by 3 AA batteries, a TASCAM PS-P520U AC adapter (sold separately) or a commercially-available USB cable (USB bus power).

Alkaline, Ni-MH or lithium AA batteries can be used.

NOTE

This unit does not have a battery charging function when using an AC adapter.

Using AA batteries

1. Remove the battery compartment cover, and install 3 AA batteries with their ⊕ and ⊖ marks as shown in the battery compartment.
2. Reattach the battery compartment cover.

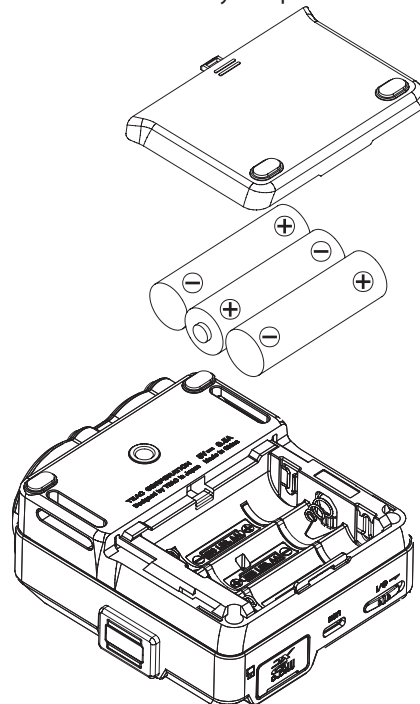

Set the type of battery in order to show the amount of power remaining and allow the unit to determine whether enough power is available for proper operation. ("Setting the AA battery type (BATTERY)" on page 61)

NOTE

When using dry cell batteries, the potential operation time will vary according to the environmental temperature and operating conditions.

For continuous operation over a long time, we recommend using an AC adapter or other external power supply.

Using an AC adapter (sold separately)

Connect a PS-P520U AC adapter (sold separately) to the unit's USB port.

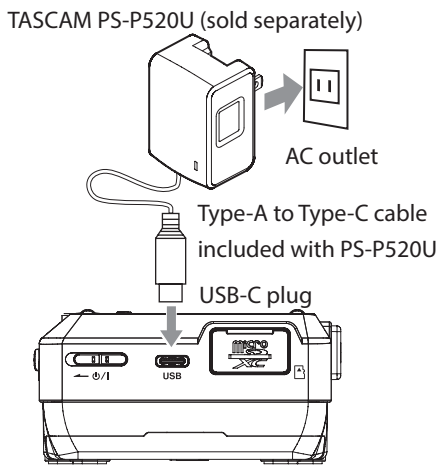

CAUTION

- We highly recommend using the PS-P520U AC adapter (sold separately) that is designed for use with this unit. When using another external power supply device, use one with the following specifications.

- Supplied voltage: 5 V
- Supplied current: 1.5 A or more

Using a power supply device with specifications other than the above could cause malfunction, overheating, fire or other problems.

If trouble should occur, stop using the unit and contact the retailer where you purchased it or a TASCAM customer support service to request repair.

- Noise may occur when recording with a microphone if the unit is too close to the AC adapter. In such a case, keep sufficient distance between the AC adapter and the unit.

NOTE

- If power supply selection is set to automatic, power will be supplied from the external source when both that source and batteries are available.
- When batteries are installed and an external power supply is connected, if the external power supply is disconnected, the unit will switch to operating on battery power.

Using USB bus power

Use the supplied USB cable to connect the unit and the computer as illustrated below.

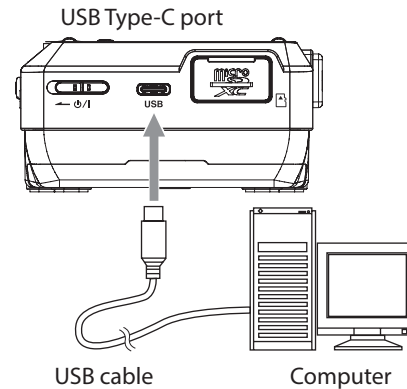

NOTE

- If a computer is going to be used only to supply power, a driver does not need to be installed.
- We recommend connecting it to a USB Type-C port on a computer or other device.

4. Preparation

4-3. Turning the unit on and off

CAUTION

Turn down the volume of the sound system connected to the unit before starting up or shutting down the unit.

Do not wear connected headphones when turning the unit on and off. Noise could damage the headphone driver unit or harm your hearing.

Turning the power on

Slide the O/I switch toward \leftarrow until the display is activated. Then, release the switch.



Start up screen

When the unit starts up, the display will become active.

Turning the unit off (putting it in standby)

Slide the O/I switch toward \leftarrow until the display turns off. Then, release the switch.

The unit turns off after it completes its shutdown process.

CAUTION

Always use the O/I switch to turn the unit off.

If the unit is not able to conduct shutdown procedures properly, recording data, settings and other changes could be lost. Lost data and settings cannot be restored.

NOTE

The unit cannot be turned off when it is recording or in recording standby.

Resume function

When this unit is turned off, it remembers the position where playback was stopped.

The next time it is turned on, playback can be started from where it was stopped.

NOTE

Since the stopped position is saved on the microSD card, it will not be saved if the microSD card is replaced while the power is on.

Set the date and time

Whenever the date and time have been reset, the DATE/TIME screen will open to enable setting them.

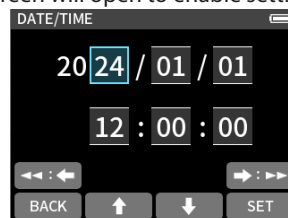

- Use the F2 [\uparrow] and F3 [\downarrow] buttons to change the values
- Use the \leftarrow [\leftarrow] and \rightarrow [\rightarrow] buttons to move the cursor
- Press the F4 [SET] button to confirm

NOTE

The date and time setting can also be changed by pressing the F1 [MENU] button when the unit is stopped and the HOME screen is open and using the MENU screen > SYSTEM > DATE/TIME item.

Formatting (initializing) microSD cards

The following message will appear if an unformatted card is loaded.

Press the F4 [OK] button to start formatting.

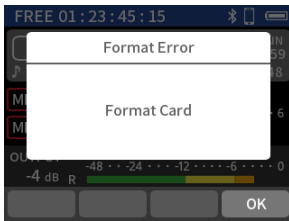

- We recommend using FULL ERASE FORMAT when formatting microSD cards the first time they are used with this unit.
- After formatting completes, the HOME screen will open.

Formatting can also be executed by pressing the F1 [MENU] button when the unit is stopped and the HOME screen is open and using the MENU screen > SYSTEM > FORMAT SD item.

1. Select "QUICK FORMAT" or "FULL ERASE FORMAT".

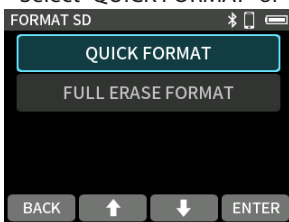

2. Press the F4 [YES] button.

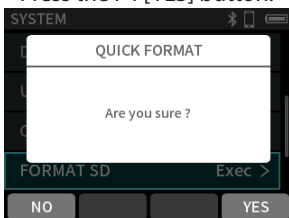

CAUTION

Formatting will erase all data on a microSD card.
Back up to a computer, for example before formatting a card.

NOTE

- Using the FULL ERASE FORMAT option might improve writing performance that has decreased due to repeated use. If "Write Timeout" or "Card slow Check BOF MARK" messages appear during recording, execute a FULL ERASE FORMAT.
- FULL ERASE FORMAT checks the memory for errors while formatting, so it takes more time than QUICK FORMAT.

4. Preparation

4-4. HOME screen

The HOME screen appears after the unit starts up.

Depending on the operation state, the HOME screen will appear one of three ways.

The functions of the F1 – F4 buttons change according to the state.

Icon

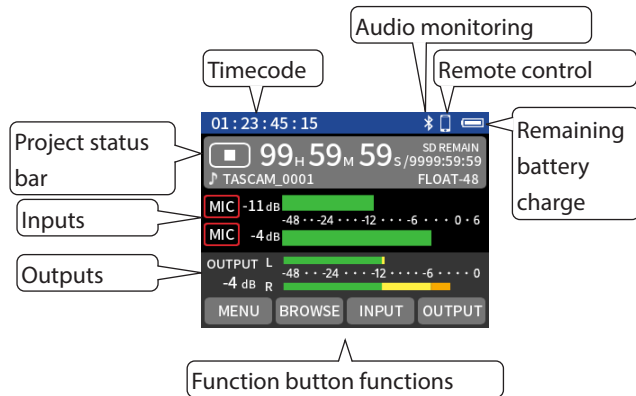

Remaining battery charge / USB connection icon

This shows the remaining charge when operating with batteries.

This will switch to the USB icon when connected by USB.

Project status bar

This shows icons for the operation state, the time of the recording/playback position and remaining microSD card capacity, for example.

Status	Indicator
Stopped	■
Recording	●
Recording paused	●
Playing	▶
Paused	

Inputs

This shows input settings and levels.

Outputs

This shows output settings and levels.

Timecode

This shows the timecode. ("Timecode selection" on page 57)

Audio monitoring

This shows the connection status of wireless audio monitoring equipment. ("Wireless audio monitoring" on page 59)

Status	Indicator
Connections	Bluetooth icon
Disconnected	No indicator

REMOTE CONTROL

This shows the connection status of remote control devices.

("Connecting with the dedicated control app" on page 55)

BLUETOOTH	Status	Indicator
REMOTE CONTROL ON	Not connected	Bluetooth icon blinking
	Connections	Bluetooth icon lit
REMOTE CONTROL OFF	-	No indicator

Function button functions

These show the functions assigned to the function buttons.

When recording/playback stopped

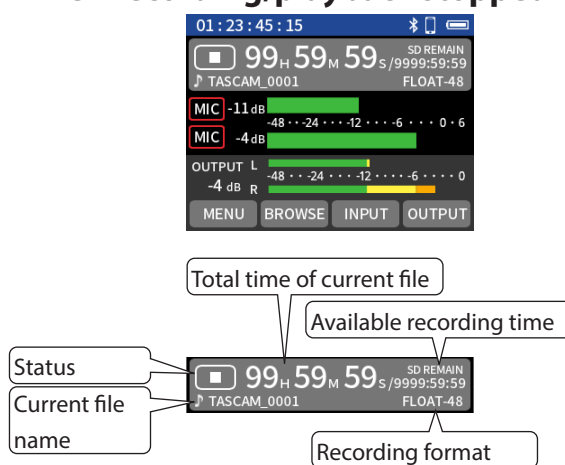

Function button	Function
F1 [MENU]	Open MENU screen (page 63)
F2 [BROWSE]	Open BROWSE screen (page 64)
F3 [INPUT]	Open INPUT SETTINGS screen (page 65)
F4 [OUTPUT]	Open OUTPUT SETTINGS screen (page 65)

When recording, in recording standby or recording paused

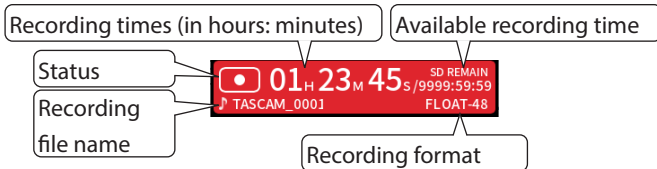
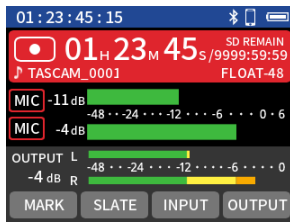

Function button	Function
F1 [MARK]	Add a mark
F2 [SLATE]	Record/output a slate tone while pressing
F3 [INPUT]	Open the INPUT SETTINGS screen
F4 [OUTPUT]	Open the OUTPUT SETTINGS screen

When playing, paused or searching forward/backward

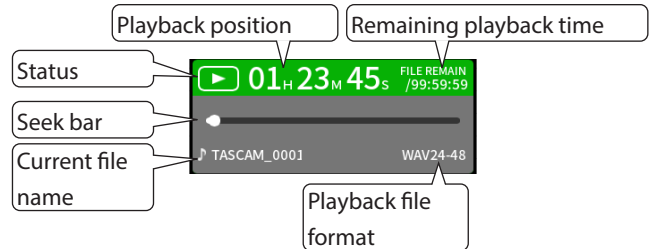
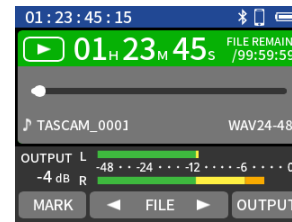

Function button	Function
F1 [MARK]	Add or clear a mark (when paused at an existing mark position)
F2 [◀ FILE]	Skip to the beginning of the previous audio file If the playback position is not already there, skip to the beginning of the file
F3 [FILE ▶]	Skip to the beginning of the next audio file (and stop if paused)
F4 [OUTPUT]	Open the OUTPUT SETTINGS screen

NOTE

The previous/next mark position can be moved to by pressing the F2 [◀ FILE] / F3 [FILE ▶] button while pressing the F1 [MARK] button.

4. Preparation

4-5. Basic operation

The function assigned to each function button (F1, F2, F3, F4) changes according to the screen shown on the display. Icons for the currently assigned functions are shown at the bottom of the display.

Setting item selection procedures

This explanation uses changing the REC SETTINGS > REC FORMAT setting as an example.

1. Use the F2 [↑] or F3 [↓] button to move the selection to "REC SETTINGS" and press the F4 [ENTER] button.

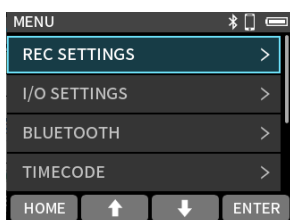

MENU screen

2. Use the F2 [↑] or F3 [↓] button to move the selection to "REC FORMAT" and press the F4 [ENTER] button.

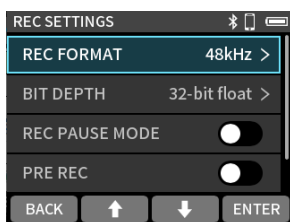

MENU > REC SETTINGS screen

3. Use the F2 [↑] or F3 [↓] button to move the selection to the value to be set.
 - The value with the ✓ on its right side is the currently set one.

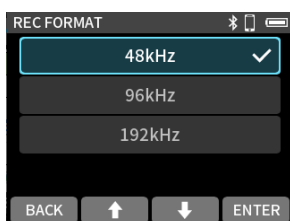

MENU > REC SETTINGS > REC FORMAT screen

4. Press the F4 [ENTER] button to confirm the setting.

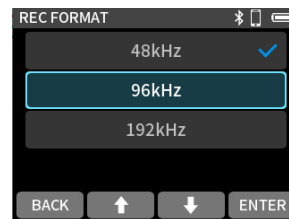

After confirming the setting, the previous screen will reopen.

To not change the setting, press the F1 [BACK] button to return to the previous screen.

Sliders

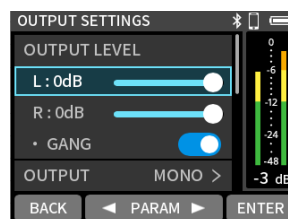

After selecting a slider, press the F2 [◀ PARAM] and F3 [PARAM ▶] buttons to adjust its position.

Slider switches

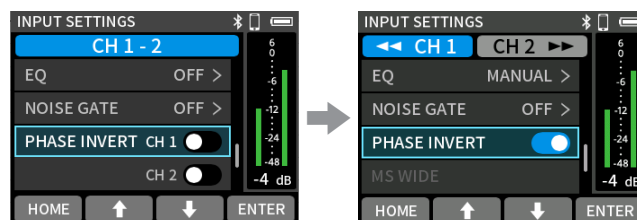

Press the F4 [ENTER] button to turn the switch on/off.

- : ON
- : OFF

Character input

A character input screen will open for items that allow characters to be input.

The example below is the character input screen that opens if the F1 [MENU] button is pressed when the unit is stopped and the HOME screen is open, and then MENU screen > SYSTEM > FILE NAME ⇄ TEXT is selected.



Use the ◀◀ and ▶▶ buttons to move the selection left and right, and the F2 [↑] and F3 [↓] buttons to move it up and down.

Move the selection to the position of the character to be input, and press the F4 [ENTER] button to input it.

To switch between inputting English alphabet letters and numbers/symbols, select the shift key and press the F4 [ENTER] button.

After completing input, select "OK" and press the F4 [ENTER] button.

To cancel input, press the F1 [BACK] button.

Pop-ups

Some pop-ups disappear after user confirmation and some disappear automatically after about two seconds.

Pop-ups that require user confirmation

After checking the message, press the F1 [NO] or F4 [YES] button to make it disappear.

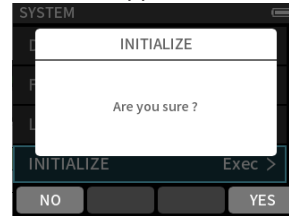

Pop-ups that disappear automatically

This will disappear automatically after about two seconds.

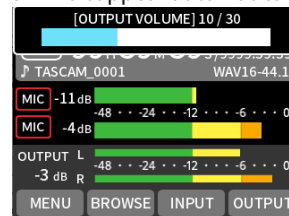

On screens that show an F4 [OK] button, press it to make the screen disappear immediately.

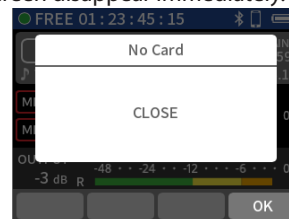

5. Connections

5-1. Connection example

Up to two inputs can be recorded.

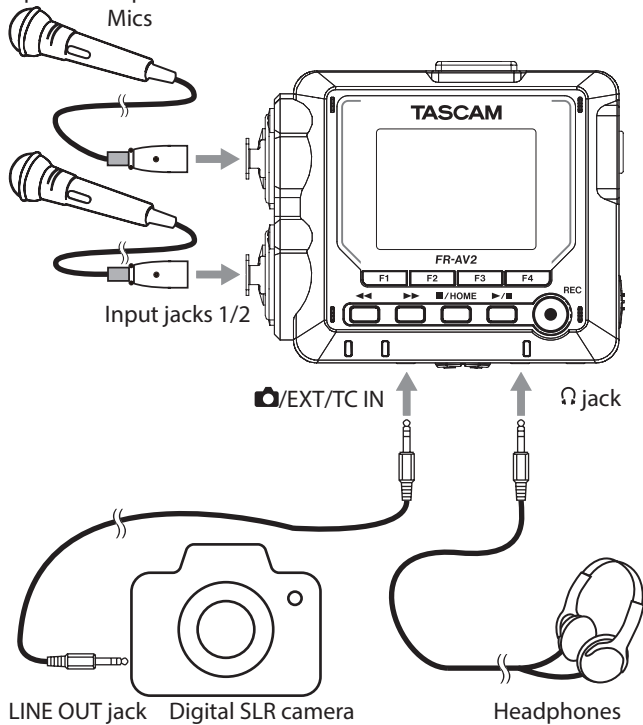

5-2. Connecting external mics and other equipment

Set INPUT SETTINGS screen > INPUT according to the connected devices. See "Setting recording input sources (INPUT)" on page 31 for details.

Connecting external mics

Connect mics to the 1/2 XLR input jacks.

Point the mics at the sound source and place the unit in a stable location where there is little vibration.

When connecting to the XLR jacks, insert the plug until a clicking sound is made. When disconnecting, pull the plug out while pressing the locking mechanism.

Example connecting to input jacks 1-2

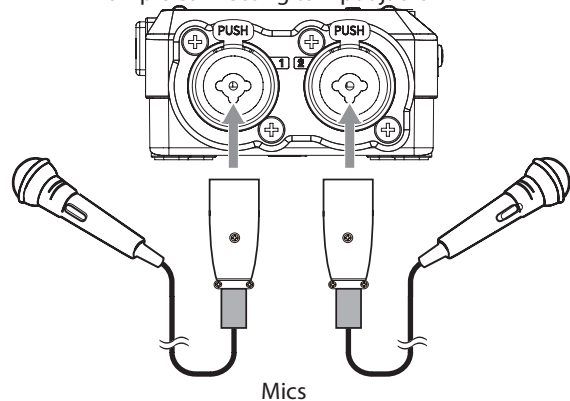

After connecting and completing input selection settings, select "MIC" for the INPUT SETTINGS screen > INPUT setting. ("Making input settings for each input" on page 30)

NOTE

- Make phantom power settings when using a mic that requires phantom power. ("Setting the phantom power voltage" on page 33)
- When connecting a device with unbalanced output, use the 📷/EXT/TC IN jack.
- Phantom power will not be supplied when using the TRS jacks.

Connecting mics that require plug-in power

Connect the mic to the /EXT/TC IN jack.

Stereo and mono mics are supported.

See “Setting plug-in power (PLUG IN POWER)” on page 31 for details about plug-in power settings.

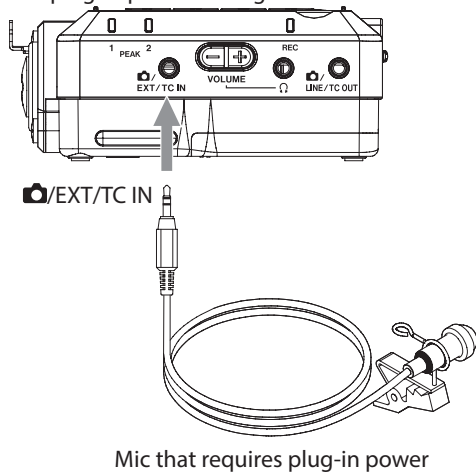

Connecting mid-side mics

Mid-side mics can be connected to input jacks 1 and 2.

Connect the mid-side mic mid to input jack 1 and the side to input jack 2.

After connection, when the unit is stopped and the HOME screen is open, press the F1 [MENU] button and set MENU screen > I/O SETTINGS > MS DECODE to “REC” or “MONITOR”. See “Using the mid-side decoding function” on page 34 for details about recording with mid-side mics.

Connecting other equipment

- Use the /EXT/TC IN jack to connect stereo mini cables. After connecting, change the INPUT SETTINGS screen > INPUT setting to “EXT”. (“Making input settings for each input” on page 30)
- To connect XLR plugs, use input jacks 1/2. After connecting, change the INPUT SETTINGS screen > INPUT setting to “LINE”. (“Making input settings for each input” on page 30)

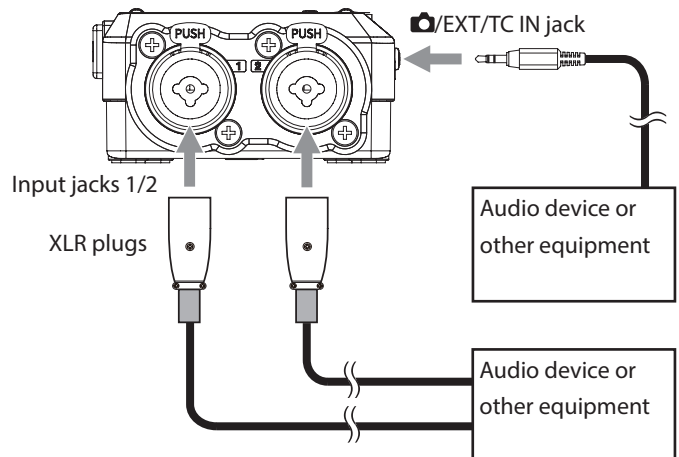

XLR plug: XLR-3-31 equivalent (1: GND, 2: HOT, 3: COLD)

TRS plug: 6.3 mm (1/4”) standard TRS jack (Tip: HOT, Ring: COLD, Sleeve: GND)

5. Connections

5-3. Connecting cameras

When recording video with a camera, the same sound can be recorded simultaneously by the camera and this unit. In order to output sound to a camera, connect it with this device as shown below.

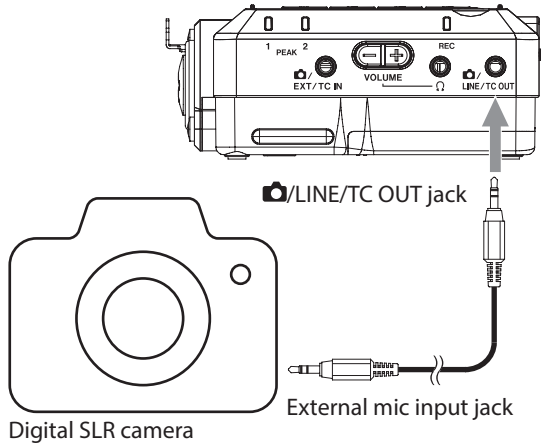

Setting output for camera use

The line output level can be attenuated up to 80 dB for camera use.

See "Setting output for camera use" on page 51 for details.

5-4. Connecting monitoring equipment

To listen with an external monitoring system (powered monitor speakers or an amplifier and speakers), connect it to the /LINE/TC OUT jack.

To listen with headphones, connect them to the Ω (headphone) jack.

Depending on the settings, monitoring might not be possible unless the REC [●] button is pushed. See "Recording operation flow" on page 38 for details.

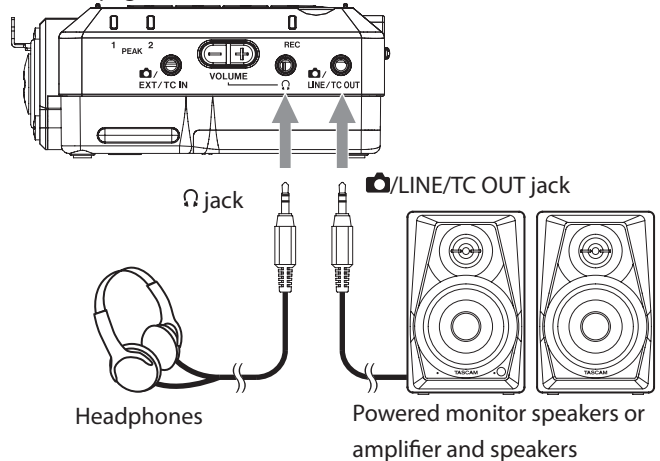

When the unit is stopped and the HOME screen is open, press the F4 [OUTPUT] button to open the OUTPUT SETTINGS screen and set it according to the connected equipment.

CAUTION

While wearing headphones, do not connect or disconnect the headphone plug or turn the unit on or put it into standby. Doing so might cause sudden loud noises, which could harm hearing.

Always set the volume to minimum (0) before putting headphones on.

NOTE

When outputting audio from the LINE output, set TC OUT LEVEL to "OFF". See "Outputting timecode" on page 58 for details.

5-5. Adjusting the headphone output volume

Use the Ω (headphone) +/- volume controls on the front panel to adjust the volume output from the Ω (headphone) jack and for wireless audio monitoring.

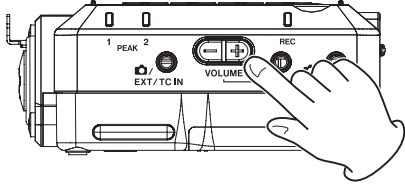

NOTE

The volume setting can also be changed by pressing the F4 [OUTPUT] button when the unit is stopped and the HOME screen is open and using the OUTPUT SETTINGS screen > OUTPUT LEVEL item. See "Adjusting the volume" on page 35 for details.

5-6. Connecting computers and smartphones

The following uses are possible when connected by USB to a computer (Windows/Mac) or smartphone.

- Simultaneously recording to a computer while recording on the microSD card in the unit (backup recording)
- Monitoring sound from the computer
- Use as a microSD card reader (only when connected to a computer)

NOTE

- When connecting this unit with an iOS device, set it to use batteries. See "Selecting the power source" on page 61 for details.
- A USB cable must be prepared to connect this unit to a computer (Windows/Mac) or smartphone. ("USB cables (for communication and data transmission)" on page 7)

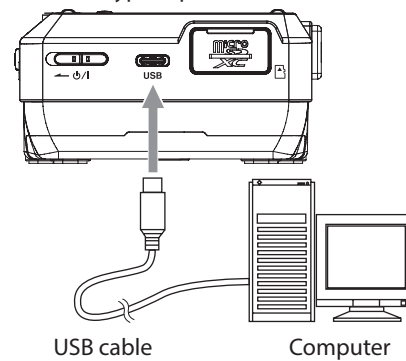

5-7. Synchronizing with timecode

See “Timecode functions” on page 57 for details about use.

Receiving timecode

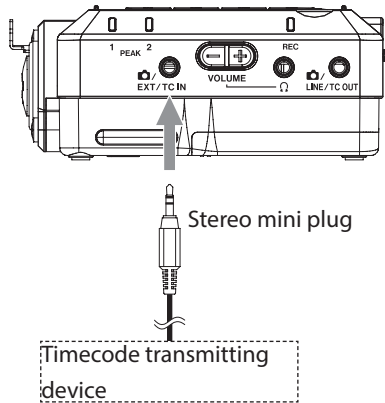

Set MENU screen > TIMECODE > TC GEN MODE > TC IN MASTER according to the connected device. See “Receiving timecode by wire” on page 57 for details.

Timecode synchronization is also possible using Bluetooth transmission. See “Connecting with this unit using Bluetooth” on page 54 for details.

Transmitting timecode

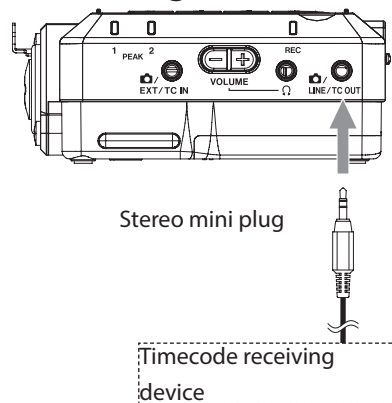

Set MENU screen > TIMECODE > TC OUT LEVEL according to the connected device. See “Outputting timecode” on page 58 for details.

Timecode connection examples

1. Using Atomos UltraSync BLUE

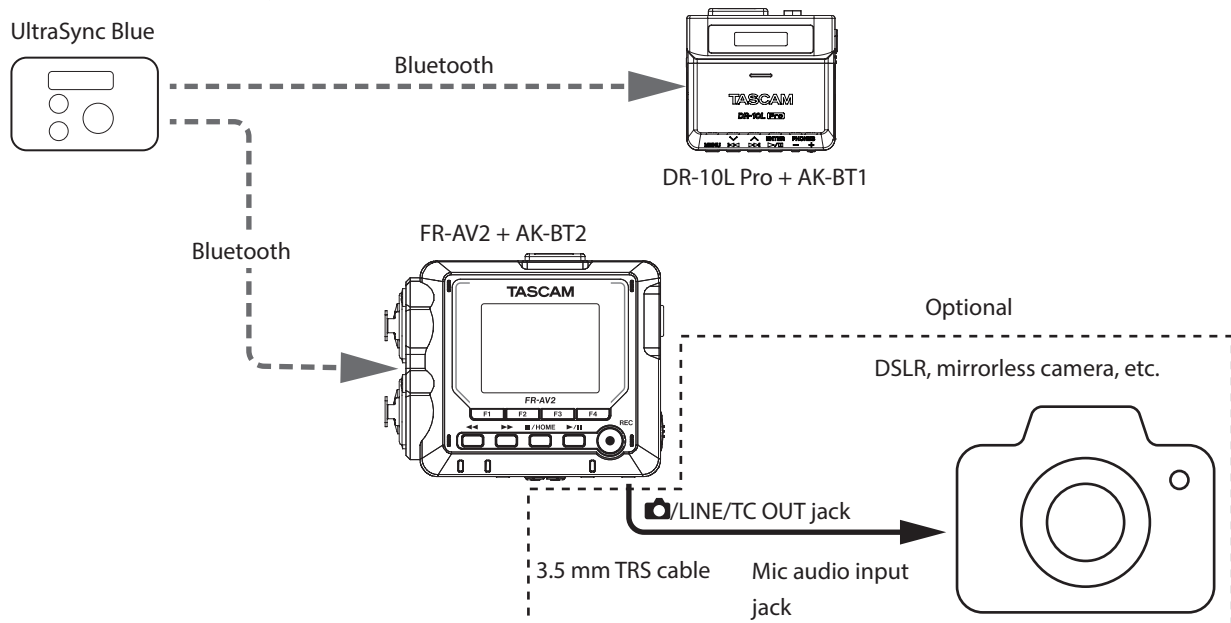

2. Example using a timecode generator

Input timecode from an external timecode generator through the TC IN jack.

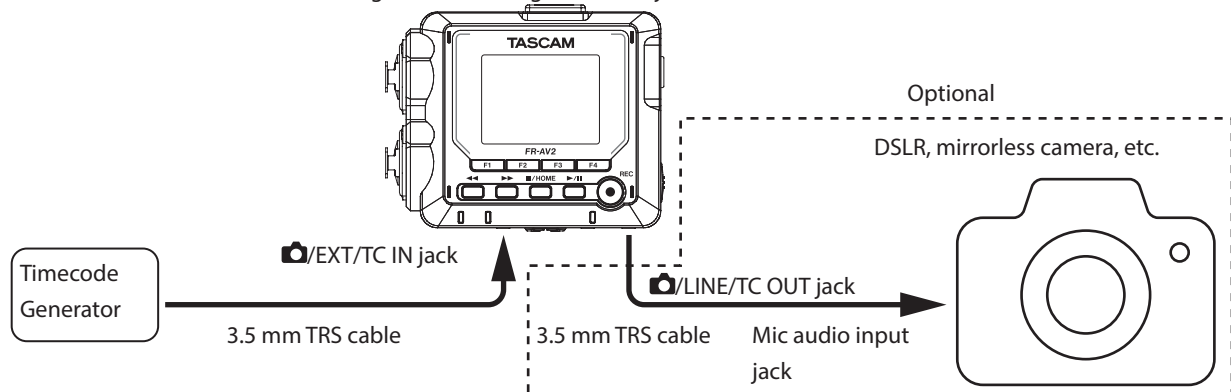

TIP

- After once synchronizing with timecode from an Atomos UltraSync Blue or a timecode generator, along with ordinary connection, it is possible to make it jam sync even if it becomes disconnected by setting it to FREE RUN.
- The FR-AV2 can become a timecode generator and provide timecode to a camera. (“Timecode functions” on page 57)
- By adding an FR-AV2 and enabling jam sync, a camera that is synchronized to timecode can also be added in the same manner as the illustration above.

6. Input and output settings

6-1. Making input settings for each input

HOME screen when stopped

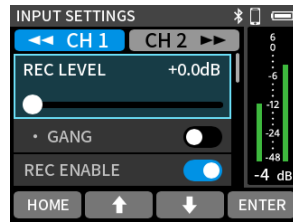
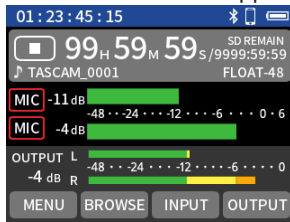

Press the F3 [INPUT] button.

(When stereo linking is off)

NOTE

- When stereo linking is off, use the ◀◀ and ▶▶ buttons to select the channel to set.
- Not all setting items are shown on a single screen. Use the F2 [↑] and F3 [↓] buttons to move the selection up and down and show the necessary items.
- Even though channels are selected to make settings, they are saved as settings for the input jacks assigned to those channels. For this reason, even if input source settings are used to change the assignments of channels and input jacks, the input jack settings will not change. The stereo link function is an exception.

Adjusting the recording level (REC LEVEL)

Select REC LEVEL and press the F4 [ENTER] button.

Use the F2 [◀ PARAM] and F3 [PARAM ▶] buttons to adjust the audio signal level used when recording files.

Options: 0dB (default) – +60.0dB

- While watching the level meter, adjust the REC LEVEL so that the level averages around –12 dB and the PEAK indicator does not light.
- The recording sound might distort when the PEAK indicator lights.

NOTE

- If the input level exceeds –2 dB, the PEAK indicator on the unit will light.

If an input level exceeds –2 dB, the PEAK indicator for that input lights

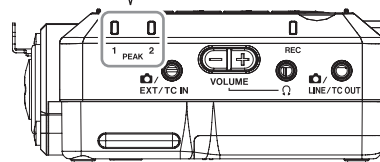

- If an overload occurs with an analog circuit, the entire level meter will become red.

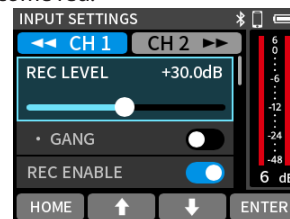

Since this could cause the recorded audio to become distorted, make the following adjustments.

- Distance the mic from the sound source.
- Lower the volume of the sound source.

Setting the GANG operation mode (GANG)

Setting the GANG operation mode allows the recording levels of channels 1 and 2 to be linked and operated simultaneously.

Select GANG and press the F4 [ENTER] button to switch the setting.

Options: OFF (default), ON

NOTE

Even if a ganged channel reaches its upper or lower limit first, operation of the current channel can continue. In this case, differences in levels are remembered by the unit. When operation of a channel is reversed, level differences will be retained when operated.

Setting channels to record (REC ENABLE)

The channels to record can be turned on/off.

Select REC ENABLE and press the F4 [ENTER] button to switch the setting.

Options: OFF, ON (default)

Setting recording input sources (INPUT)

The input sources of channels can be set.

When using input jacks 1 and 2, select "MIC" or "LINE".

When using /EXT/TC IN, select "EXT".

When using computer output as audio input to this unit, select "USB".

Options when stereo linking is off: MIC (default), LINE, EXT, USB

Options when stereo linking is on: MIC (default), LINE, EXT (ST), EXT (MONO), USB

- When "LINE" is selected, the input signal is attenuated 22 dB.

Stereo linking (STEREO LINK)

Audio from channels 1–2 can be recorded as stereo audio files.

Select STEREO LINK and press the F4 [ENTER] button to switch the setting.

Options: OFF (default), ON

- When STEREO LINK is ON, the following settings for channel 1 will be applied to channel 2.
INPUT / DELAY / LOW CUT / DYNAMICS / EQ / NOISE GATE

Appearance when STEREO LINK is ON

HOME screen when stopped

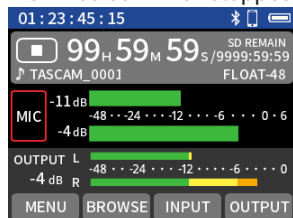

INPUT SETTINGS screen

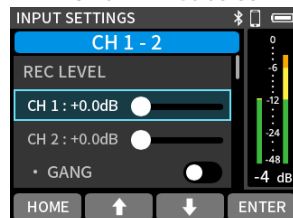

Using phantom power (PHANTOM)

Make this setting when using mics that require phantom power.

Select PHANTOM and press the F4 [ENTER] button to switch ON/OFF the setting.

See "Setting the phantom power voltage" on page 33 for details about phantom power voltage settings.

Options: OFF (default), ON

NOTE

This setting is only valid when the input source setting is "MIC".

Setting plug-in power (PLUG IN POWER)

Options: OFF (default), 2.5V, 5V

When connecting a microphone that requires plug-in power, set this to "2.5V" or "5V".

CAUTION

Do not turn plug-in power on when a mic is connected that does not require it. Doing so could damage the connected equipment.

See the mic operation manual for details.

Compensating for mic distances (DELAY)

Use this function to compensate for delays that result from differences in distances between connected mics.

Options: 0 (default) – 300 ms

Use the F2 [◀ PARAM] and F3 [PARAM ▶] buttons to adjust.

Setting the low-cut filter (LOW CUT)

This cuts audio below the selected frequency.

The low-cut filter can reduce bothersome noise, such as from wind, air-conditioners and projectors.

Set the cutoff frequency of the low-cut filter to match the noise.

Options: OFF (default), 40Hz, 80Hz, 120Hz, 220Hz

Setting the limiter (DYNAMICS)

Using the limiter can suppress distortion caused by sudden excessive sound input.

OFF (default)

The limiter function is disabled.

LIMITER

This function prevents distortion when signals that are too loud are input suddenly.

This is suited for recording live performances and other situations with large volume changes.

CAUTION

Distortion could occur when the input sound is excessively loud even if the limiter function is on. In such a case, lower the input level or increase the distance between the unit and the source.

COMP

This increases the levels of low-level input signals and adjusts high-level input signals so that they do not become any higher. This does not have a function to prevent distortion.

This is suited for recording situations that have large volume changes without excessive input levels, for example.

6. I/O SETTINGS

Setting the equalizer (EQ)

The equalizer has the effect of amplifying and attenuating specific frequency ranges. This can be used, for example, to enhance the sound of individual instruments, to adjust the balance of a wide frequency range and to cut specific unwanted frequencies.

OFF (default)

This disables the equalizer.

INTERVIEW

This setting is good for recording sound in interviews, meetings, podcasts and similar conversational situations.

MUSIC

The setting is good for emphasizing heavy low frequencies in band performances, for example.

MANUAL EQ

With this setting, four bands can be adjusted manually. In addition to low-frequency and high-frequency boosts, two peak curves can be set.

Gain knobs (HIGH, H-MID (high mid), L-MID (low mid), LOW)

These set the amounts levels are increased or decreased for each band.

Ranges

GAIN: -12 dB – +12 dB (0 dB by default)

FREQ knobs (HIGH, H-MID, L-MID, LOW)

These set the cutoff frequencies of the HIGH and LOW bands and the middle frequencies of the H-MID and L-MID bands.

Ranges

HIGH: 1.7 kHz – 18.0 kHz (5.5 kHz by default)

H-MID: 32 Hz – 18.0 kHz (1.7 kHz by default)

L-MID: 32 Hz – 18.0 kHz (1.7 kHz by default)

LOW: 32 Hz – 1.6 kHz (400 Hz by default)

Q knobs (H-MID/L-MID)

These set the acuteness of these bands.

The higher the value is the more acute it becomes, making it affect a narrower frequency band around the set frequency.

The lower the value is the less acute it becomes, making it affect a broader frequency band around the set frequency.

Ranges

H-MID: 0.25 – 16.00 (default 2.00)

L-MID: 0.25 – 16.00 (default 2.00)

MANUAL EQ

This 4-band parametric EQ can be adjusted manually.

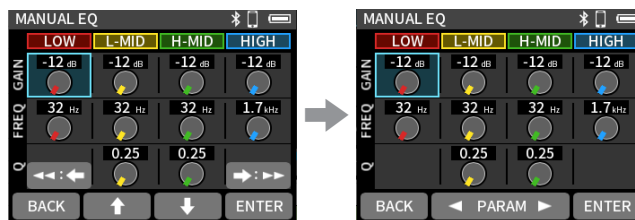

Use the ◀ [PARAM], F2 [↑], F3 [↓] and ▶ [PARAM] buttons to select the knob to adjust and press the F4 [ENTER] button.

Use the F2 [◀ PARAM] and F3 [PARAM ▶] buttons to adjust.

Press the F4 [ENTER] button to enable knob selection again.

Examples of EQ characteristics

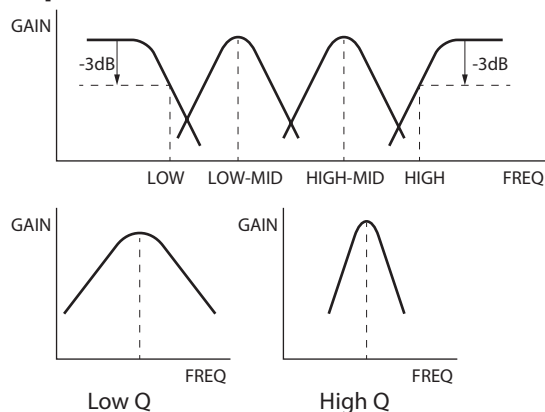

Setting the noise gate (NOISE GATE)

Sound below a set level can be muted.

When "LOW" is selected, only quiet sounds will be muted. When "HIGH" is selected, sounds up to a certain level will also be muted.

Options: OFF (default), LOW, MID, HIGH

Inverting the input phase (PHASE INVERT)

Turning this on will invert the phase.

Select PHASE INVERT and press the F4 [ENTER] button to switch the setting.

Options: OFF (default), ON

NOTE

If the sound seems to be unclear when recording the same source with more than two or more mics, inverting the phase of one or more inputs could improve the sound quality.

6-2. Setting the phantom power voltage

Press the F1 [MENU] button when the unit is stopped and the HOME screen is open and open the MENU screen > I/O SETTINGS screen.

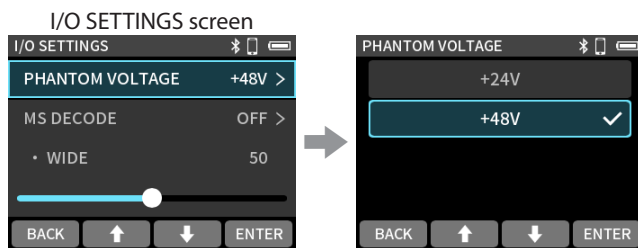

Select PHANTOM VOLTAGE and press the F4 [ENTER] button.

Select the voltage and press the F4 [ENTER] button.

NOTE

- Turn phantom power output on/ off on the INPUT SETTINGS screen. ("Using phantom power (PHANTOM)" on page 31)
- The default value is "+48V".
- Battery power will be consumed faster when set to "+48V" than when set to "+24V".

CAUTION

- Do not connect or disconnect mics with the INPUT 1/2 jacks when phantom power is on. Doing so could cause a loud noise and might damage this unit and connected equipment.
- Turn phantom power ON only when using a condenser microphone that requires phantom power. Turning phantom power on when a dynamic mic or other external device that does not require it is connected could damage this unit and the connected equipment.
- When using condenser mics that require phantom power and dynamic mics together, be sure to use balanced dynamic mics. Unbalanced dynamic mics cannot be used when phantom power is enabled.
- Supplying phantom power to some ribbon mics could break them. If you are unsure, do not supply phantom power to a ribbon mic.
- Some condenser microphones will not operate when phantom power is set to "+24V".
- Battery operation time will change according to the mics being used. For details, refer to the operation manual of the mic, for example.

- When using phantom power while running on batteries, the operation time might be reduced greatly depending on the mics being used. We recommend using a TASCAM PS-P520U AC adapter (sold separately). Furthermore, when using an adapter that does not meet the recommended specifications, supplying phantom power to multiple inputs could cause the power to turn off automatically.
- Do not connect or disconnect the AC adapter when using phantom power. The unit could turn off even when batteries are installed, resulting in recorded data becoming damaged or lost.
- When using USB bus power, the unit might not be able to supply phantom power depending on the computer. In this case, set the unit to use battery power.

6-3. Using the mid-side decoding function

Mid-side mics can be used for recording, and their recordings played back.

See “Connecting mid-side mics” on page 25 for details about connecting mid-side mics.

Connection settings

Set the jacks that the mid-side mics are connected to using the MENU screen > I/O SETTINGS > MS DECODE item.

HOME screen when stopped

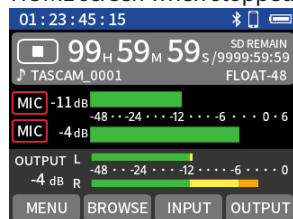

Press the F1 [MENU] button.

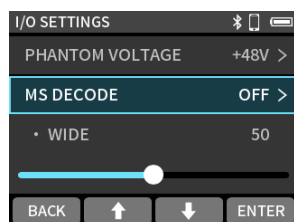

Select I/O SETTINGS > MS DECODE and press the F4 [ENTER] button.

OFF (default)

The mid-side decoding function will not be used. Recording will occur in ordinary mode.

REC

This mode decodes while recording. Playback is conducted without decoding.

MONITOR

Record mid-side mic output without decoding for decoding later. Use this mode to monitor when recording with mid-side mics. Use this also when playing back mid-side files that were recorded without decoding.

NOTE

- The mid-side decoding function can be used when inputting mid-side mics through the 1/2 input jacks and when using this unit to play imported files recorded using mid-side mics. Turn the mid-side decoding function off to not use it.
- Always stereo-link the inputs to which mid-side decoding is applied. See “Stereo linking (STEREO LINK)” on page 31 for operation procedures.

Adjusting mid and side levels

I/O SETTINGS screen

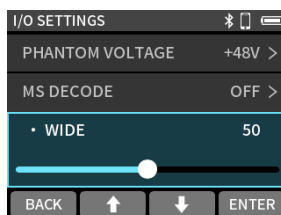

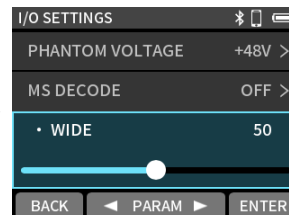

Select WIDE and press the F4 [ENTER] button.





Use the F2 [◀ PARAM] and F3 [PARAM ▶] buttons to adjust the width of the sound.

- At 0, the sound will be 100% mid (M). The amount of side (S) increases with the value. The default value is 50%.

6-4. Adjusting the volume

Use this to adjust the volume output from the  (camera), LINE OUT and  (headphone) jacks and used for wireless audio monitoring.

- The volume used for  (headphone) output and wireless audio monitoring can also be adjusted using the  (headphone) volume control on the unit.

HOME screen

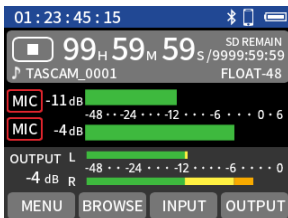

Press the F4 [OUTPUT] button.

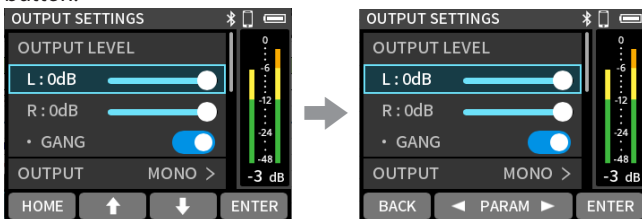

Select the output to adjust and press the F4 [ENTER] button.

Use the F2 [◀ PARAM] and F3 [PARAM ▶] buttons to adjust it.

GANG operation

The L and R volumes are affected when adjusted depending on the GANG setting.

ON (default)

SOLO control is possible while maintaining the L/R balance.

OFF

Separate control of the OUTPUT LEVEL is possible for L and R.

Output sound (OUTPUT)

Set with the OUTPUT SETTINGS screen > OUTPUT item.

MONO (default), STEREO

The output sound can be switched between mono and stereo.

Adjusting mid and side levels (MS WIDE)

This setting can be adjusted while monitoring the mic sounds by setting MENU screen > I/O SETTINGS > MS DECODE to "MONITOR". See "Connection settings" on page 34 for details.

OUTPUT SETTINGS screen

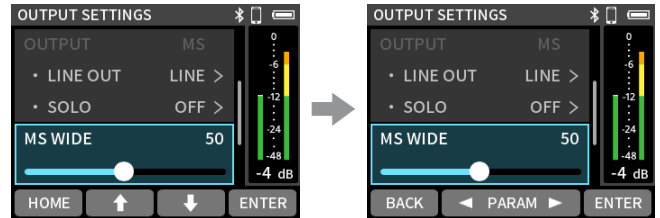

Select MS WIDE and press the F4 [ENTER] button.

Use the F2 [◀ PARAM] and F3 [PARAM ▶] buttons to adjust the width of the sound.

- At 0, the sound will be 100% mid (M). The amount of side (S) increases with the value. The default value is 50.

LIMITER

This function prevents distortion when signals that are too loud are output suddenly.

Options: OFF (default), ON

CAUTION

Distortion could occur if the output sound is excessively loud even when the limiter function is on. In such a case, lower the output level manually.

DELAY

The amount of delay time to the output device can be adjusted. This function is convenient for adjusting video and audio on a connected camera.

Options: OFF (default) – 300 ms

- Use the F2 [◀ PARAM] and F3 [PARAM ▶] buttons to adjust this.

6-5. Saving and recalling input settings

The following input settings can be saved and recalled.

- REC LEVEL
- GANG
- DELAY
- LOW CUT
- DYNAMICS
- EQ (MANUAL EQ)
- NOISE GATE

A maximum of 3 presets can be saved.

NOTE

Before saving and when the system has been initialized, they will be set to their default values.

Saving presets

1. Press the F3 [INPUT] button when the unit is stopped and the HOME screen is open to open the INPUT SETTINGS screen.

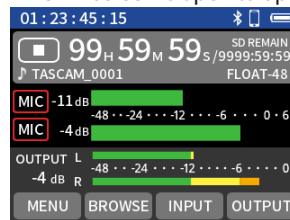

2. When stereo linking is off, use the ◀◀ and ▶▶ buttons to select the channel to be saved.

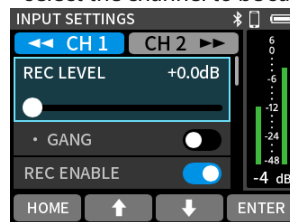

3. Use the F2 [↑] or F3 [↓] button to move the selection up or down to select "PRESET SAVE" and press the F4 [ENTER] button.

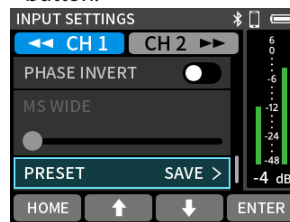

4. When a screen for selecting the saving location opens, select the desired PRESET using the F2 [↑] and F3 [↓] buttons. Then, press the F4 [ENTER] button.

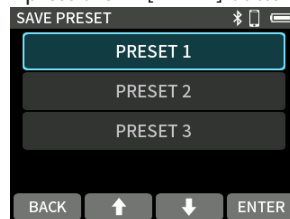

5. When a confirmation pop-up opens, press the F4 [YES] button.



Loading presets

1. Press the F3 [INPUT] button when the unit is stopped and the HOME screen is open to open the INPUT SETTINGS screen.

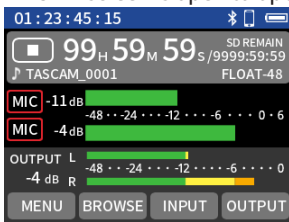

2. When stereo linking is off, use the ◀◀ and ▶▶ buttons to select the channel to be loaded.

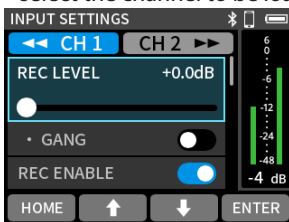

3. Use the F2 [↑] or F3 [↓] button to move the selection up or down to select "PRESET LOAD" and press the F4 [ENTER] button.

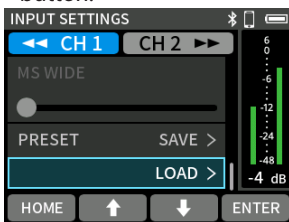

4. Select the PRESET to load using the F2 [↑] and F3 [↓] buttons. Then, press the F4 [ENTER] button.

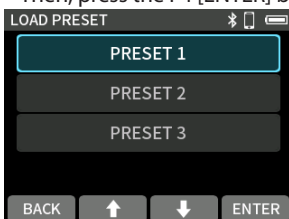

The HOME Screen will reopen after the preset is loaded.

7. Recording

7-1. Overview of recording

Recording pause/standby function (REC PAUSE MODE)

This unit has a function called "REC PAUSE MODE". With it, pressing the REC [●] button will put the unit into recording standby, and pressing REC [●] again will start recording.

A recording can be started and paused repeatedly without stopping, allowing it to be saved as a single file. (This is only when the recording hold function is off.)

The recording pause function is off when shipped new from the factory.

When the recording pause function is off, the input signal is always monitored.

When the recording pause function is on, the input signal is only monitored when recording is paused or in progress.

Set the recording pause function using the MENU screen > REC SETTINGS > REC PAUSE MODE item.

NOTE

If the recording pause function is activated, monitoring of input signals is disabled when recording is stopped, allowing power consumption to be reduced.

Recording hold function (REC HOLD)

This function is to prevent recording from being unintentionally stopped by misoperation. When this function is on, recording can be stopped by pressing and holding the STOP button.

- The recording hold function is on when shipped new from the factory.

Set the recording hold function using the MENU screen > REC SETTINGS > REC HOLD item.

Recording operation flow

Depending on the REC PAUSE MODE on/off setting, pressing buttons will have the following effects.

Recording pause function off

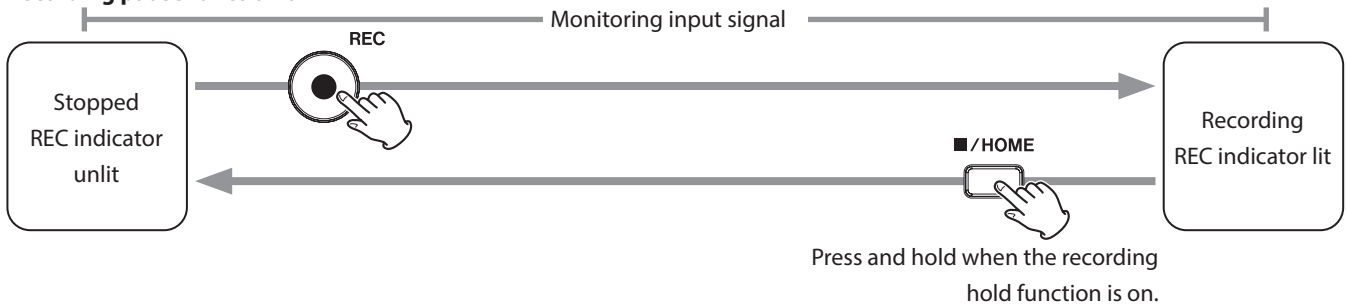

Recording pause function on

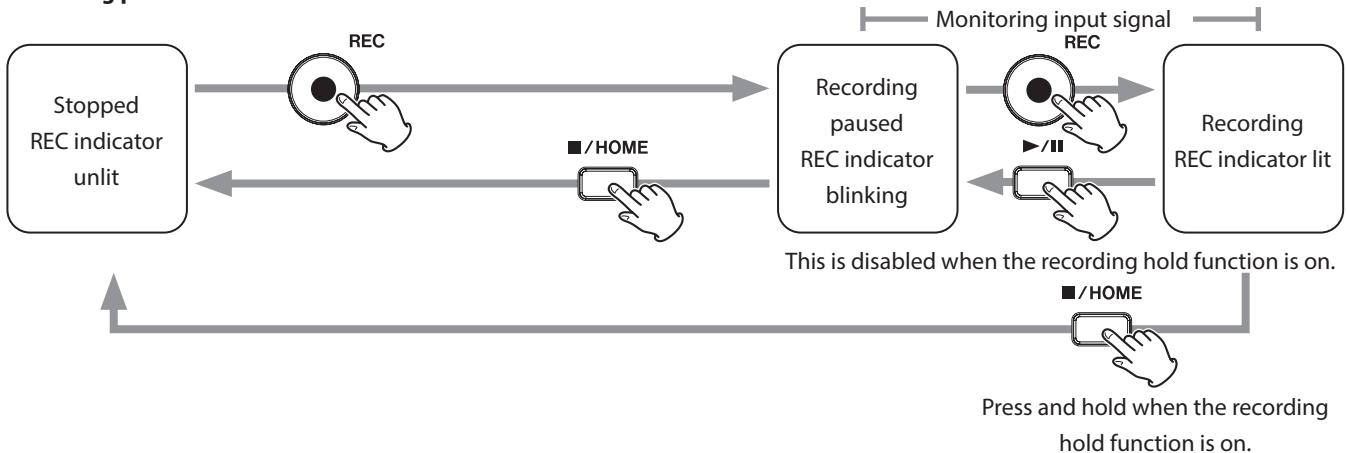

7-2. Button operations during recording

Recording pause function on

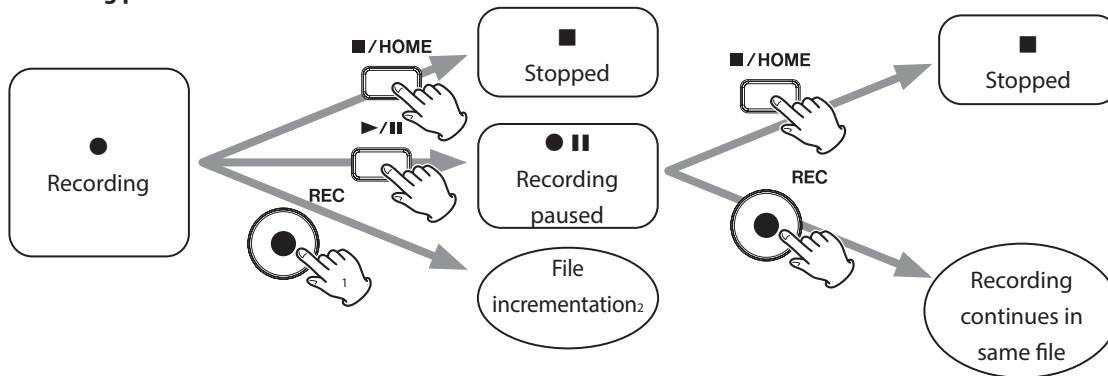

Recording pause function off

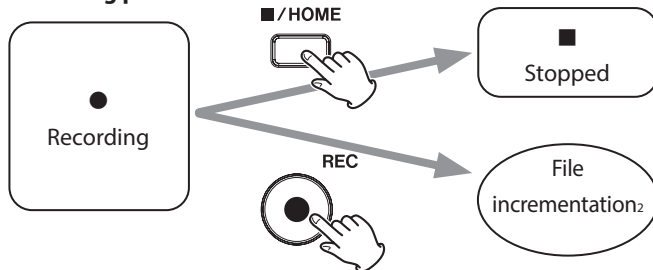

¹ This is disabled when the recording hold function is on.

² See "Changing files while continuing to record (file incrementation function)" on page 41 for information about file incrementation.

8. Recording settings

8-1. Monitoring individual inputs (SOLO)

Press the F4 [OUTPUT] button when the unit is stopped and the HOME screen is open, and use OUTPUT SETTINGS screen > SOLO to select the channel to monitor by itself (solo).

Options: OFF (default), CH 1, CH 2

NOTE

This turns off automatically when recording.

8-2. Changing the recording file format

Press the F1 [MENU] button when the unit is stopped and the HOME screen is open to open the MENU screen.

Set this with the MENU screen > REC SETTINGS > REC FORMAT item.

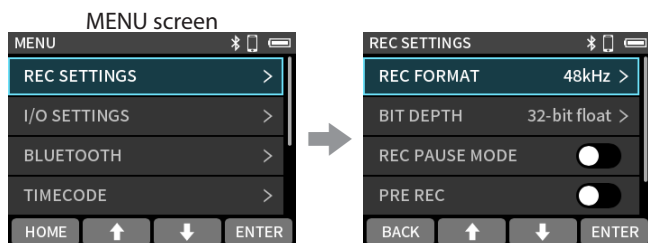

Select REC SETTINGS and press the F4 [ENTER] button.

Select the setting item and press the F4 [ENTER] button.

REC FORMAT

Select the sampling frequency.

Options: 48kHz(default), 96kHz, 192kHz

BIT DEPTH

Select the bit depth.

Options: 24-bit, 32-bit float (default)

32-bit float

This unit supports 32-bit float recording. Files recorded using 32-bit float have the following advantages when being edited afterward.

- The levels of quiet sounds can be raised without changing their original sound qualities.
- Sounds that seem clipped can be restored to unclipped sounds by lowering their volumes.

CAUTION

Analog clipping will not be changed when volume is lowered.

8-3. Pausing when recording (REC PAUSE MODE)

See "Recording pause/standby function (REC PAUSE MODE)" on page 38 for details.

8-4. Capturing sound before recording starts (PRE REC)

Press the F1 [MENU] button when the unit is stopped and the HOME screen is open and set it using the MENU screen > REC SETTINGS > PRE REC item.

When the prerecording function is on and the unit is in recording standby, it can record up to 5 seconds of signal input before recording is started.

Options: OFF (default), ON

NOTE

When REC FORMAT is set to 192kHz, the PRE REC function can capture signals a maximum of 2 seconds before recording starts.

8-5. Recording file naming

See "File name overview" on page 43 for details.

8-6. Designating the folder used for recordings

See "File operations" on page 43 for details.

8-7. Changing files while continuing to record (file incrementation function)

Press the REC button on the unit while recording to start a file with a new number.

NOTE

- The number at the end of the file name will increase when a new file is created.
- If the name of the new file to be created would be the same as that of an existing file, "---" will be added after the number. (--- is a three-digit number, starting with "001".)
Example: YMMDD_0001[001]-1.wav
- A new file cannot be created if the total number of files and folders would exceed 1000.

8-8. Recording times (in hours: minutes)

File format (recording setting)		Card capacity	
		32GB (microSDHC)	128 GB (microSDXC)
WAV 24-bit (stereo linking on)	48 kHz	30:50	123:26
WAV 24-bit (stereo linking on)	96 kHz	15:25	61:43
WAV 24-bit (stereo linking on)	192 kHz	7:42	30:51
WAV 32-bit float (stereo linking on)	48 kHz	23:8	92:32
WAV 32-bit float (stereo linking on)	96 kHz	11:34	46:16
WAV 32-bit float (stereo linking on)	192 kHz	5:47	23:8

- The recording times shown above are estimates. They might differ depending on the microSD card in use.
- The recording times shown above are not continuous recording times, but rather they are the total possible recording times for the microSD card.
- When stereo linking is off and recording only 1 channel, the above recording times will be about twice as long.

NOTE

If the size of a file exceeds 4 GB during recording, a new file will be created and recording will continue in that file (file incrementation). See "File name overview" on page 43 for information about file names.

9. Playing files

9-1. Open the playback screen

HOME screen when stopped

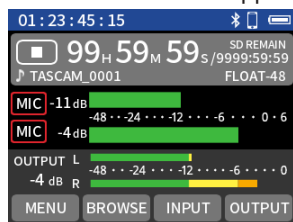

Display example

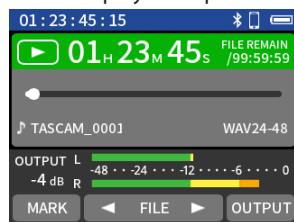

The last recorded file will play back.

Screen overview

Project status bar

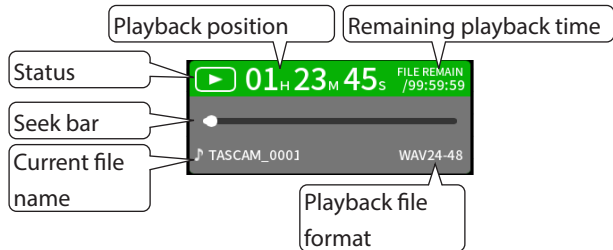

Playing and pausing

When stopped or paused, press the ►/|| button to start playback.



Stopping playback

During playback, press the ■/HOME button to stop playback.



Moving the playback position (searching backward/forward)

The playback position can be moved by pressing the ◀◀ and ▶▶ buttons on the unit to search backward and forward.

When searching, pressing the button of the same movement direction will increase the speed while pressing the opposite button will slow the speed.

The movement speed can be switched between three levels.

NOTE

Moving to another file is not possible when changing the playback position by searching forward or backward.

Selecting files for playback

Use the F2 [◀ FILE] and F3 [FILE ▶] buttons to select the desired file for playback.

Pressing the F2 [◀ FILE] button during playback will return to the beginning of the file. Pressing the F2 [◀ FILE] button at the beginning of a file will skip to the beginning of the previous file. If you press the F3 [FILE ▶] button when located at the beginning or middle of a file, the playback position will skip to the beginning of the next file.

Seeking backward and forward momentarily

Press and hold the ◀◀ or ▶▶ button on the unit to seek backward or forward while pressing.

Recording data is saved in the SOUND folder on the microSD card. This unit can record and play wav (including BWF) files.

10-1. File name overview

Files recorded by this unit are named as described below.

Project name Channel
 ┌──────────┬──────────┐
 TASCAM_0001-1.wav

Characters set by File number
 user

Characters set by user

When FILE NAME is set to DATE

YYMMDD (YY: year, MM: month, DD: date)

The last two digits of the year are used, and two digits each are used for the month and day.

When FILE NAME is set to TEXT

A string of 6–9 characters can be specified as wanted.

The default value is “AV2-00000”.

The usable characters are as follows.

Uppercase and lowercase alphabet letters numerals 0–9, and the following symbols:

! # \$ % & ' () + , - . : ; = @ [] ^ _ ` { } ~ (space)

File numbers

This shows the order recorded.

The default value is “0001”.

Channel number

This shows which channel was recorded.

When stereo-linking off

Channel number 1 or 2

When stereo-linking on

Linked channel numbers 1_2

Project name

This is the characters set by the user and the file number connected by an underscore (_).

Since the file number is increased each time a file is recorded, the project also changes with each recording. See “Project overview” on page 45 for details about projects.

NOTE

If a file with the same user-set characters and file number already exists at the time of recording, “[---]” will be added after the file number. (--- is a three-digit number, starting with “001”.)

Example: YYMMDD_0001[001]-1.wav

Changing how files are named

Press the F1 [MENU] button when the unit is stopped and the HOME screen is open to open the MENU screen.

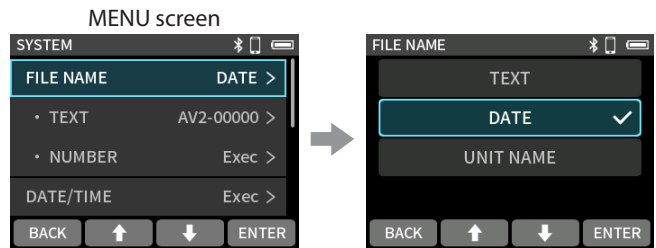

Select SYSTEM > FILE NAME, and press the F4 [ENTER] button.

Select the setting and press the F4 [ENTER] button.

FILE NAME

Set the characters used at the beginning of the file name.

DATE (default)

The DATE is added to the file name.

YYMMDD (YY: year, MM: month, DD: date)

The last two digits of the year are used, and two digits each are used for the month and day.

TEXT

The 6–9 characters set freely using TEXT are added to the file name.

The default value is “AV2-00000”.

UNIT NAME

The name of the individual device is used for the file name.

NOTE

- If DATE is selected, the file name will be created using the date and time of the unit’s internal clock. Set the clock in advance to enable recording with the correct date and time.
- The UNIT NAME must be set in advance using the dedicated control app. See the manual for the dedicated control app for setting procedures. If the UNIT NAME has not been set, “FR-AV2” will be used for file names.

TEXT

Press the F1 [MENU] button when the unit is stopped and the HOME screen is open, and set it using MENU screen > SYSTEM > FILE NAME • TEXT.

See “Character input” on page 23 for details about character input.

Setting the file number

Press the F1 [MENU] button when the unit is stopped and the HOME screen is open to open the MENU screen.

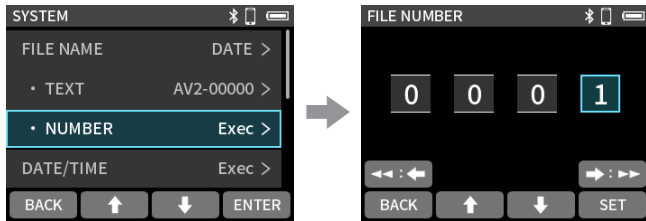

Select SYSTEM > FILE NAME
• NUMBER and press the F4 [ENTER] button.

- Use the F2 [↑] and F3 [↓] buttons to change the values
- Use the ← [←] and → [→] buttons to move the cursor
- Press the F4 [SET] button to confirm

NOTE

- If a file with the same name and number already exists at the time of recording, “[---]” will be added after the file number. (--- is a three-digit number from 001 to 999.)
- This will be disabled if the METADATA function has been turned on using the dedicated control app.

10-2. File and project structure overview

Folders

Formatting microSD cards with this unit will create SOUND and UTILITY folders.

Recording data is saved in the SOUND folder by default.

Folders can be created inside the SOUND folder.

Create them as necessary. (“Creating folders (NEW FOLDER)” on page 47)

Recording data

Recording data is saved in the current folder. After a microSD card is formatted, the SOUND folder becomes the current folder.

To change the current folder, select the folder on the BROWSE screen, and select OPEN. (“Setting where recording projects are saved” on page 49)

10-3. Folder hierarchy example

This illustration is an example of the folder hierarchy on a microSD card used with this unit.

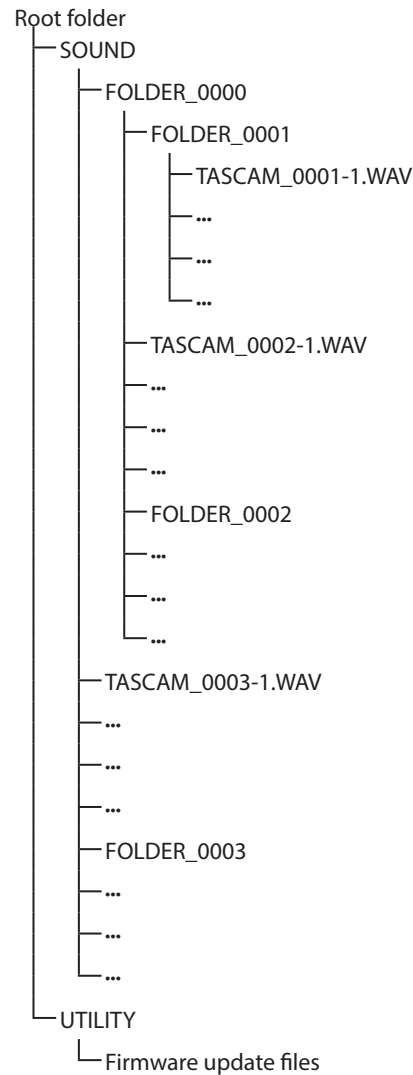

- SOUND and UTILITY folders will be created automatically during formatting.
- Only two levels of subfolders can be created.
- The maximum total number of files and folders is 1000.
- Everything in the SOUND folder and its subfolders is shown on the BROWSE screen.

10-4. Project overview

Files created during a single recording are referred to as a project. Files belong to the same project if their names are the same from the characters set by the user through the file numbers. See “File name overview” on page 43 for details about project names. The way project names are given can be changed in the same manner as for file names. (“Changing how files are named” on page 43)

Example

Project name	Files in the same project
TASCAM_0001	TASCAM_0001-1.WAV TASCAM_0001-2.WAV
TASCAM_0002	TASCAM_0002-1_2.WAV

- Individual files not created by this unit and loaded from a computer or other source are each treated as a single project.

10-5. Using the BROWSE screen

Files on the loaded microSD card can be worked with and easily played back.

HOME screen when stopped

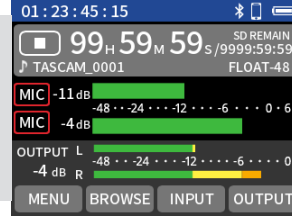

BROWSE screen

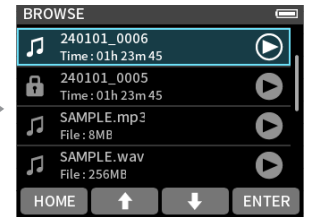

Press the F2 [BROWSE]

button.

Function button	Function
F1 [HOME]	Open HOME screen
F2 [↑]	Move selection (highlighted area above) up by one (nothing happens if top item already selected)
F3 [↓]	Move selection (highlighted area above) down by one (nothing happens if bottom item already selected)
F4 [ENTER]	Confirm selected folder or file

NOTE

If a microSD card is not loaded, the following screen will appear.

Press the F1 [HOME] button to return to the HOME screen.

Then, insert a microSD card.



10-6. Folder operations

Screen overview

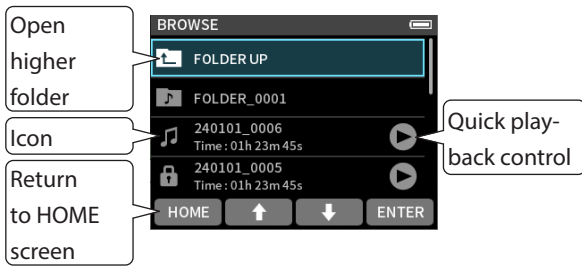



Icon

Musical note icons are shown next to files that can be played. Folders are shown with .

Folder/file name

Press the F4 [ENTER] button to open the folder/file menu.

Quick playback control

Press the  button to start playback. During playback, press /HOME to stop.

Moving between folders

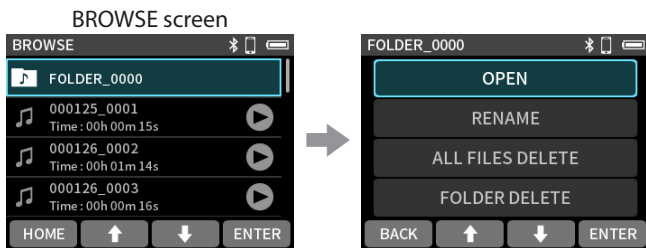



Select the folder to move to and press the F4 [ENTER] button.

Select OPEN and press the F4 [ENTER] button.

- To move up a folder level, select “FOLDER UP”.

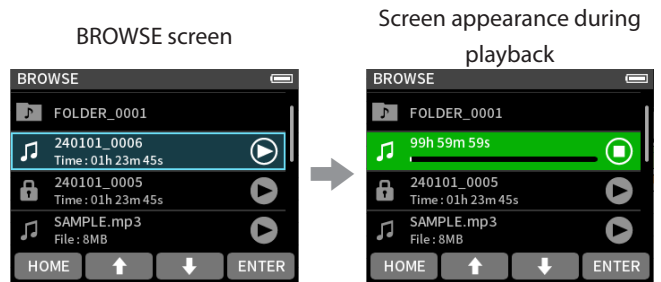
Quick file playback



Select the file to play and press the  button.

Press the /HOME button to stop playback.

- Quick file playback does not include pausing or searching forward/backward functions. See “Open the playback screen” on page 42 to pause and search forward/backward.

Folder menu

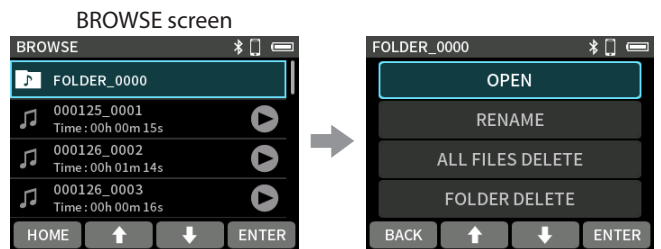

Select a folder and press the F4 [ENTER] button.

Select an item and press the F4 [ENTER] button.

OPEN

This shows the contents of the folder.

RENAME

This opens the RENAME screen where the folder name can be edited.

ALL FILES DELETE

This deletes all projects and files inside the folder. Folders, however, will not be deleted.

FOLDER DELETE

This deletes the folder.

Creating folders (NEW FOLDER)

BROWSE screen

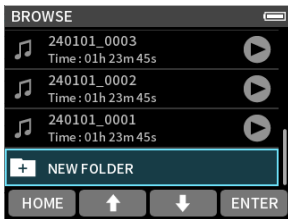

Select NEW FOLDER and press the F4 [ENTER] button.

- If a folder named FOLDER+number already exists, selecting "NEW FOLDER" and pressing the F4 [ENTER] button will show FOLDER+ (the number+1) as the default value. If you want to change this name, use the RENAME function.
- See "Character input" on page 23 for how to input characters.



Input the folder name and press the F4 [ENTER] button.

Changing the names of folders (RENAME)

Select the desired folder on the BROWSE screen and press the F4 [ENTER] button. Then, follow the procedures below.

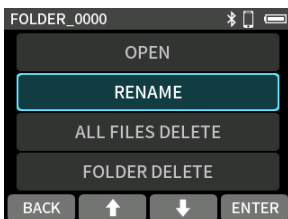

Select "RENAME" and press the F4 [ENTER] button.

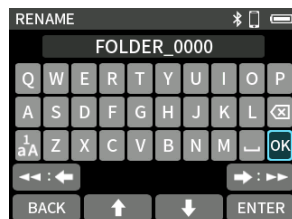

Input the folder name and press the F4 [ENTER] button.

- See "Character input" on page 23 for how to input characters.
- Folder names that can be changed can have between 1 and 11 characters.

Deleting all files in a folder (ALL FILES DELETE)

BROWSE screen

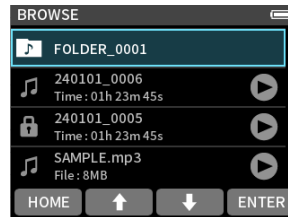

Select a folder and press the F4 [ENTER] button.

FOLDER menu screen

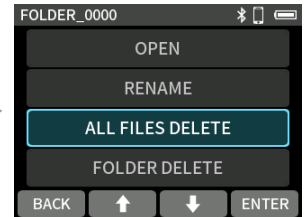

Select ALL FILES DELETE and press the F4 [ENTER] button.

NOTE

The selected folder will not be deleted.

Deleting folders (FOLDER DELETE)

1. Select the desired folder on the BROWSE screen and press the F4 [ENTER] button.
2. Select FOLDER DELETE and press the F4 [ENTER] button.

NOTE

Folders that have files remaining in them cannot be deleted. Delete all the files in the folder before deleting the folder.

10-7. File and project operations

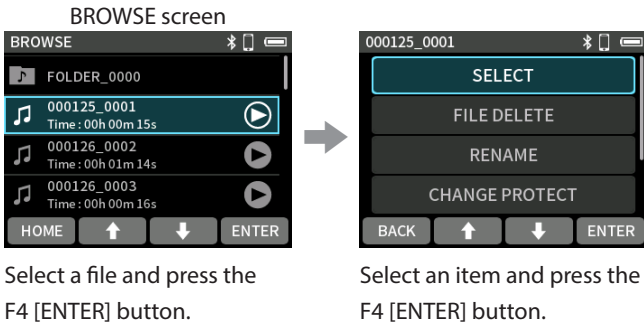

Select a file and press the F4 [ENTER] button.

Select an item and press the F4 [ENTER] button.

File menu

SELECT

This sets the selected file as the current project.

FILE DELETE

This deletes the file.

RENAME

Use this to change the project name.

Only projects that have been recorded by this unit can be changed. The number of characters can be changed to between 6 and 9.

CHANGE PROTECT

Use this to activate/deactivate the protection of files in the project.

FILE INFORMATION

This shows information about files in the project.

MARK

This opens a list of the marks.

Selection (SELECT)

Selecting a file makes it the current project and reopens the HOME screen.

Press the ► / ||| button on the unit to play the current project.

Current project determination

The name of the file shown in the project status bar is the current project. Conducting recording or playback will switch the current project.

Deleting projects (FILE DELETE)

1. Select the project to delete on the BROWSE screen and press the F4 [ENTER] button.
2. Select FILE DELETE and press the F4 [ENTER] button.

NOTE

Protected (read only) files cannot be deleted.

Changing names (RENAME)

Project names can be changed.

1. Select the file with the name to be changed on the BROWSE screen and press the F4 [ENTER] button.
 2. Select RENAME and press the F4 [ENTER] button.
 3. Input the new file name and press the F4 [ENTER] button.
- See “Character input” on page 23 for how to input characters.

Enabling and disabling protection (CHANGE PROTECT)

Project protection can be enabled and disabled.

1. Select the name of the file with protection to be changed on the BROWSE screen and press the F4 [ENTER] button.
2. Select CHANGE PROTECT and press the F4 [ENTER] button. This enables or disables protection.

NOTE

Lock marks (🔒) are shown for icons of files that are protected.

File information (FILE INFORMATION)

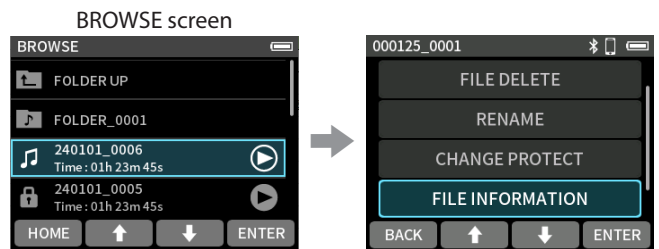

Select the name of a project and press the F4 [ENTER] button.

Select FILE INFORMATION and press the F4 [ENTER] button.

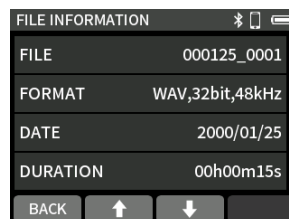

This shows the project name, recording format, recording date, playback time and file size.

Viewing mark lists (MARK)

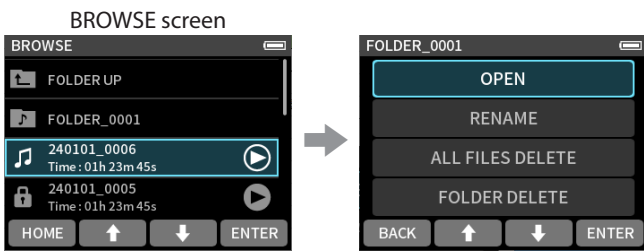

Select the name of a project and press the F4 [ENTER] button.

Select MARK and press the F4 [ENTER] button.

A list of marks will be shown

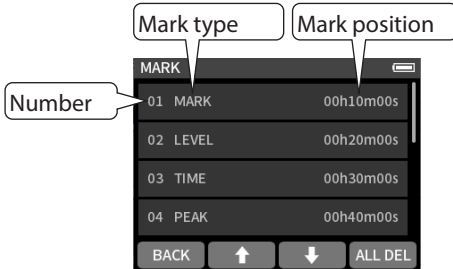

See “Mark functions” on page 50 for information about mark types.

Deleting marks

Press the F4 [ALL DEL] button when the MARK list screen shown above is open to delete all marks.

NOTE

See “Deleting marks” on page 50 for details about the deleting individual marks.

10-8. Setting where recording projects are saved

Recording data is saved in the current folder.

Follow the procedures below to select a folder and make it the current folder.

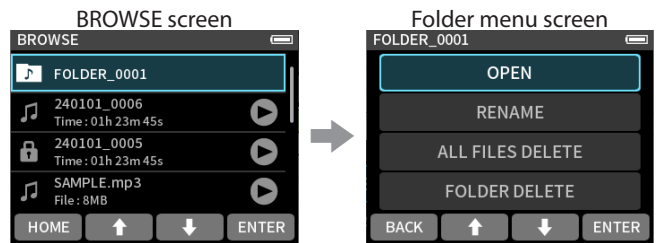

Select a folder to make it current and press the F4 [ENTER] button.

Select OPEN and press the F4 [ENTER] button.

NOTE

When the current project is selected, its folder becomes the current folder.

11. Mark functions

11-1. Mark types

The types of marks and conditions when they are added are as follows.

MANUAL

Marks added manually

TIME

Marks added when set time elapses

PEAK

Marks added when input signal exceeds peak level

BUFFER OVERFLOW (BOF)

Marks added when microSD card write errors occur during recording

11-2. Adding marks

STOP screen when stopped

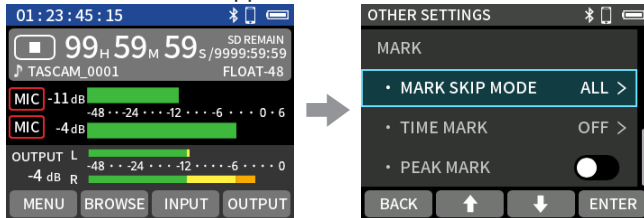

Press the F1 [MENU] button.

Select OTHER SETTINGS and press the F4 [ENTER] button.

Adding marks automatically (TIME MARK)

Set with the MARK • TIME MARK item.

OFF (default)

Marks will not be added automatically.

5min, 10min, 15min, 30min, 60min

Marks will be added automatically when the set time elapses during recording.

Adding marks when peak levels occur (PEAK MARK)

Set with the MARK • PEAK MARK item.

When this is on, marks will be added automatically when input signals exceed the peak level during recording. This can be used after recording to find parts where the peak level was exceeded.

Options: OFF (default), ON

Adding marks manually

When playing, recording or in recording standby, press the F1 [MARK] button on the unit to add a mark at any point.

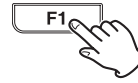

When a mark is added, a pop-up with mark information appears at the top of the display.

11-3. Deleting marks

A mark can be deleted by pressing the F1 [MARK] button when stopped or paused at its position. When a mark is deleted, a pop-up with information about the deleted mark appears at the top of the display.

Deleting all marks

See "Deleting marks" on page 49 for details.

11-4. Jumping to set marks (MARK SKIP MODE)

The previous/next mark position can be moved to by pressing the F2 [◀] / F3 [▶] button while pressing the F1 [MARK] button.

Options: ALL (default), MANUAL, TIME, PEAK, BOF

NOTE

Marks in different files cannot be skipped to.

11-5. Opening the mark list

See "Viewing mark lists (MARK)" on page 49 for details.

12-1. Setting output for camera use

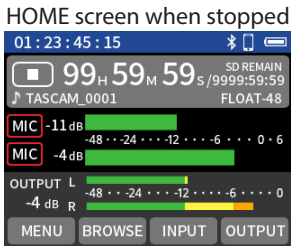

Press the F4 [OUTPUT] button.

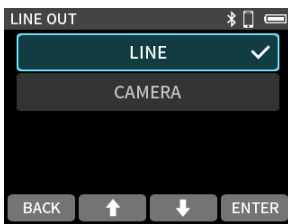

Select the item to set and press the F4 [ENTER] button.

LINE (default)

Output from the /LINE/TC OUT jack will not be attenuated. By adjusting the OUTPUT LEVEL, it can be attenuated by 0 – -60 dB. This enables inputting audio to the camera at a suitable level.

CAMERA

Output from the /LINE/TC OUT jack will be attenuated by -20 dB. By adjusting the OUTPUT LEVEL, it can be attenuated by -20 – -80 dB.

See “Adjusting the volume” on page 35 for details about adjusting the OUTPUT LEVEL.

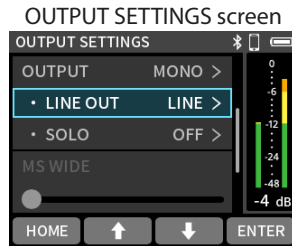

Select OUTPUT SETTINGS > OUTPUT • LINE OUT and press the F4 [ENTER] button.

12-2. Using the automatic tone function (SLATE TONE • AUTO)

The auto tone function can be used to automatically insert a tone signal whenever recording starts and stops. By connecting the /LINE/TC OUT jack on the left side of the unit to the audio input jack of a camera, both units can record the same tone signals to their files. These tones can be used as guides to synchronize files in video editing software.

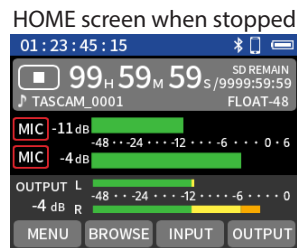

Press the F1 [MENU] button.

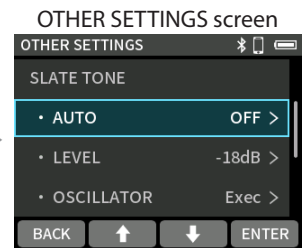

Select OTHER SETTINGS > SLATE TONE and press the F4 [ENTER] button.

Auto tone function (AUTO)

Set where tone signals are inserted.

OFF (default)

No tone signals are inserted.

HEAD

Tone signals are only inserted at the start of recording.

HEAD+TAIL

Tone signals are inserted at both the start and end of recording.

Tone volume adjustment function (LEVEL)

Set the tone volume.

Options: -12dB, -18dB (default), -24dB, -30dB, -36dB

Oscillator function (OSCILLATOR)

This outputs a tone signal.

Use this to check the level on a connected camera.

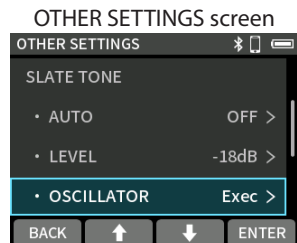

Select OSCILLATOR and press the F4 [ENTER] button.

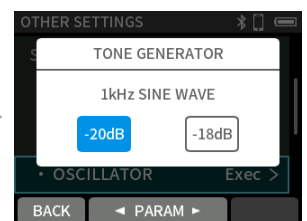

Use the F2 [◀ PARAM] and F3 [PARAM ▶] buttons to adjust the output level.

13. USB connection

13-1. Connecting with computers

See “Connecting computers and smartphones” on page 27 for details.

13-2. Connecting with iOS devices

To connect with an iOS device with a lightning connector, a Lightning to USB Camera Adapter and a USB cable (Type-A to Type-C) are necessary.

To connect with an iOS device with a Type-C connector, a USB cable (Type-C to Type-C) is necessary.

NOTE

- This unit will not provide power to an iOS device when they are connected.
- Set the power supply to battery power.

13-3. Accessing microSD cards from a computer

The unit display will change. The microSD card in the unit can be accessed when it is recognized by the computer.

HOME screen when stopped

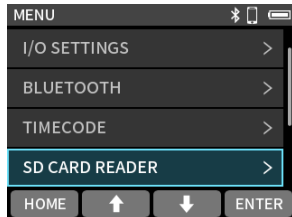
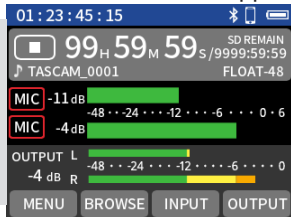

Press the F1 [MENU] button.

Select SD CARD READER and press the F4 [ENTER] button.

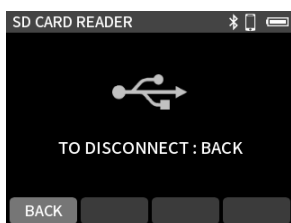

To disconnect from a computer

Follow the specified procedures for the computer to remove the media. Then, press the F1 [BACK] button.

Exchanging files with computers

Click the “FR-AV2” drive on the computer to show the “SOUND” and “UTILITY” folders.

To transfer files from the computer, drag and drop the desired audio files on the computer to the SOUND folder. To transfer files from the microSD card to the computer, drag and drop the desired audio files from the SOUND folder to any folder on the computer.

TIP

- The SOUND folder can be managed from the computer.
- Subfolders can be created in the SOUND folder. Only two levels of subfolders can be created. This unit cannot recognize subfolders and files beyond three levels.

NOTE

Follow the procedures specified for the computer to disconnect the unit from it before removing a microSD card from the unit or pressing the F1 [BACK] button.

13-4. Using the ASIO driver

With Windows, an ASIO driver for the FR-AV2 can be used. Check the page for this product on the TASCAM website for details.

<https://tascam.com/>

NOTE

With a Mac, the standard OS driver will be used, so there is no need to install any software.

13-5. Using as an audio interface

This unit can be used as a USB audio interface by connecting it to a computer using a USB cable.

- Sound played back on this unit can be output over USB.

When a microSD card is loaded

1. Manually set this unit and the computer to use the same sampling frequencies.
See "Changing the recording file format" on page 40 for procedures to change the sampling frequency of this unit.
2. After changing the sampling frequency, starting recording or recording standby will cause audio to be transmitted.

When a microSD card is not loaded

This unit will operate using the sampling frequency of the computer.

FR-AV2 USB audio channel assignments

USB channels	Signals
USB IN 1-2	Input signals from either inputs 1-2 or CAM/EXT/TC IN according to selection

- Only the REC LEVEL and PHASE settings are enabled for the selected inputs and applied to the signals sent to the computer.

NOTE

The automatic power saving function is disabled when in USB audio interface mode.

Inputting sound to the computer using the unit inputs

1. Use a USB cable to connect the computer and the unit.
2. Set the audio input device to "FR-AV2" on the computer.
Set this unit and the computer to use the same bit depths and sampling frequencies.
3. Set "REC ENABLE" to "ON" for the channels that are assigned to the input connectors that you want to use as inputs to the computer.

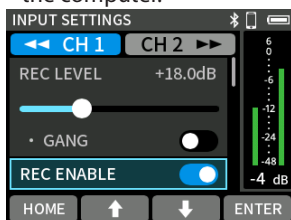

See "Slider switches" on page 22 for slider switch setting procedures.

Using the computer output as sound input to this unit

1. Use a USB cable to connect the computer and the unit.
2. Set the audio output device to "FR-AV2" on the computer.
Use the same sampling frequency settings for both the unit and the computer.
3. Press the F3 [INPUT] button when the unit is stopped and the HOME screen is open.



4. Select INPUT and press the F4 [ENTER] button.

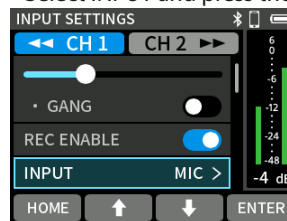

5. Select USB for the channels to which sound from the computer is assigned.

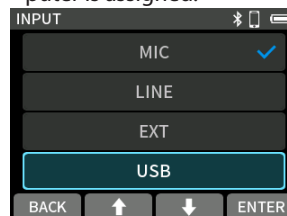

6. Set "REC ENABLE" to "ON" for the channels that USB is assigned to.

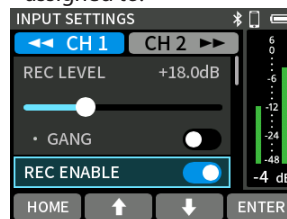

See "Slider switches" on page 22 for slider switch setting procedures.

NOTE

Adjust the USB volume from the computer.

14. Remote control functions

When an AK-BT2 Bluetooth adapter (sold separately) is connected to the Bluetooth device connector of this unit, this unit can be controlled from an iOS/Android device using a controller app. TASCAM RECORDER CONNECT can simultaneously control up to 5 FR-AV2 and DR-10L Pro units.

Moreover, TASCAM RECORDER CONNECT can also retain information for up to 99 FR-AV2 and DR-10L Pro units.

CAUTION

- Connection operations are not guaranteed with all devices that support Bluetooth.
- TEAC CORPORATION will bear no responsibility should any data loss occur when using Bluetooth functions.

NOTE

The unobstructed transmission distance of the AK-BT2 Bluetooth adapter is about 10 m. (The transmission distance is only an estimate. The transmission distance may vary depending on the surrounding environment and radio wave conditions.)

14-1. Installing the dedicated controller app

1. Connect the device to the Internet.
 2. Search for "TASCAM RECORDER CONNECT" on Google Play for an Android device or on the App Store for an iOS device. Then, download and install it.
- Please be aware that you are responsible for any transmission costs related to Internet connection.

14-2. Connecting with this unit using Bluetooth

1. Remove the cover from the Bluetooth connection device port on this unit, and install an AK-BT2 in it.

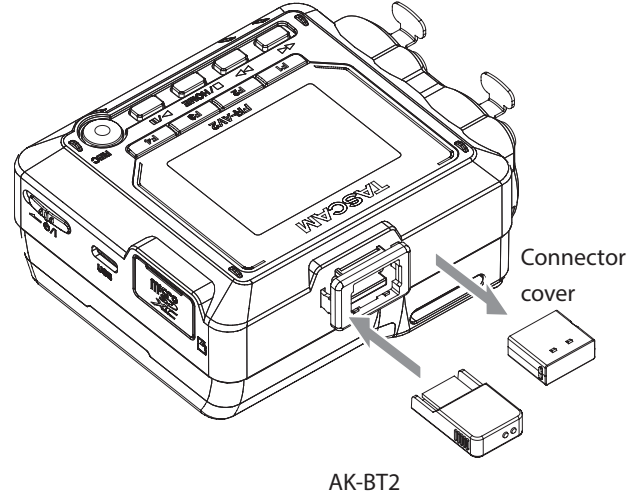

- Insert it so that the connector is toward the screen.
2. Enable Bluetooth connection on the smartphone or tablet.

CAUTION

- Do not execute pairing from the Bluetooth device list screen of an iOS/iPadOS or Android device. Always launch TASCAM RECORDER CONNECT and conduct pairing.
- When using an Android device, set Location to "On", and set "Location permission" for TASCAM RECORDER CONNECT to "Allow" or "Allow only while in use".

NOTE

Refer to the operation manual of the Bluetooth device for procedures.

14-3. Connecting with the dedicated control app

1. Use the smartphone or tablet to launch TASCAM RECORDER CONNECT.

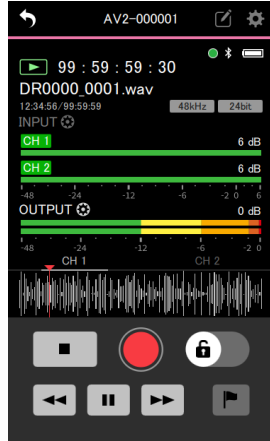

Bluetooth device screen

2. If the unit is not turned on, turn it on.
3. On this unit, set MENU screen > BLUETOOTH > REMOTE CONTROL to "ON".
The default value is "OFF".

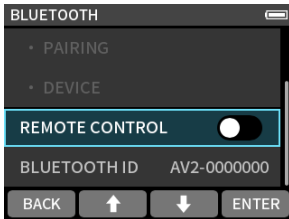

The connection status can be checked with the blinking state of the smartphone icon at the top right of the HOME screen.

Blinking state	Status
Unlit	Not paired
Blinking	Waiting to pair
Lit	Paired

When connection completes, the display of the smartphone or tablet will automatically switch to the operation screen.

NOTE

- See the TASCAM RECORDER CONNECT operation manual for details about using the control app.
- In the control app, this unit will be recognized according to its MENU screen > BLUETOOTH > BLUETOOTH ID setting.

14-4. Wireless timecode synchronization with supported Atomos products

By connecting a Bluetooth adapter (AK-BT2 sold separately) to the Bluetooth device connector on this unit, connection with, for example, AtomX SYNC and UltraSync BLUE devices by Atomos Pty Ltd to receive timecode is possible. Received timecode is written to the files recorded by this unit. Using this timecode data simplifies the aligning of video and audio files created by multiple units.

NOTE

- Set MENU screen > TIMECODE > TC GEN MODE to "BLE MASTER". ("Timecode selection" on page 57)

Connecting with supported Atomos products

Remove the cover from the Bluetooth connection device port and install an AK-BT2 in this unit before conducting the following operations.

HOME screen when stopped

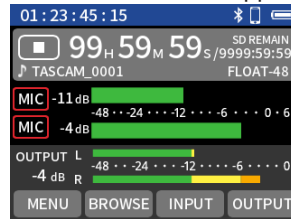

Press the F1 [MENU] button.

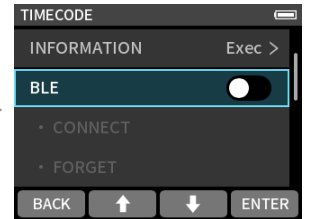

Select TIMECODE > BLE and press the F4 [ENTER] button.

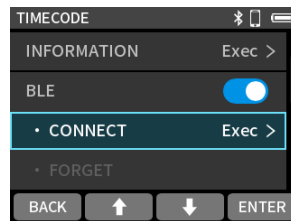

Select BLE • CONNECT and press the F4 [ENTER] button.

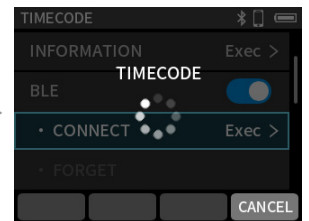

After pairing completes, "CONNECT" will appear dimmed.

- Pairing operations are also necessary on the Atomos product being paired. Refer to the operation manual of the device being used for procedures.
- See "TIMECODE INFORMATION" on page 58 for details about checking timecode information.

Connecting and disconnecting with supported Atomos products

Press the F1 [MENU] button when the unit is stopped and the HOME screen is open, and set MENU screen > TIMECODE > BLE to "OFF".

14. Remote control functions

Connecting a different AtomX SYNC, UltraSync BLUE or similar device

Unpairing first is necessary to switch connection from an already paired AtomX SYNC/UltraSync BLUE or similar device to a different device.

1. Press the F1 [MENU] button when the unit is stopped and the HOME screen is open, and set MENU screen > TIMECODE > BLE to "ON".
2. Select TIMECODE > BLE • FORGET and press the F4 [ENTER] button to clear the pairing data.
3. Select TIMECODE > BLE • CONNECT and press the F4 [ENTER] button to search for and pair with an AtomX SYNC/ UltraSync BLUE or similar device.

Appearance when connected with an AtomX SYNC, UltraSync BLUE or similar device

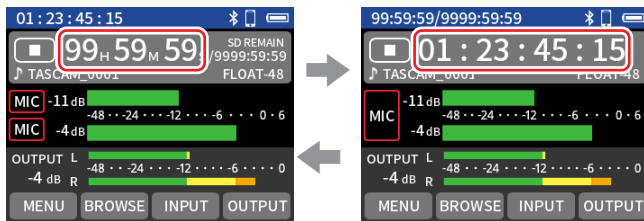

Displaying hours, minutes and seconds

Displaying received timecode

Press and hold the F4 button to switch between displaying hours, minutes and seconds and received timecode.

Connection status

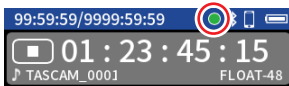

Blinking green	Receiving timecode from an AtomX SYNC, UltraSync BLUE or similar device
Blinking red	Running by itself based on the last received timecode
Unlit	Already paired, but not receiving timecode or running by itself

Using remote control while timecode is running free

The remote control app can be used with the unit running free using the timecode that it last received.

1. Turn on the timecode function and synchronize the timecode with a supported Atomos product. ("Connecting with supported Atomos products" on page 55)
2. End timecode synchronization with the supported Atomos product. ("Connecting and disconnecting with supported Atomos products" on page 55)

The unit will start running freely based on the last received timecode data.

NOTE

Free running will use the clock position of this unit.

3. Connect with the TASCAM RECORDER CONNECT dedicated control app. ("Connecting with the dedicated control app" on page 55)

The above procedures allow the remote control app to be used with the unit while it is running free using the timecode that it last received.

15. Timecode functions

Follow the procedures below to show the TIMECODE settings menu.

HOME screen when stopped

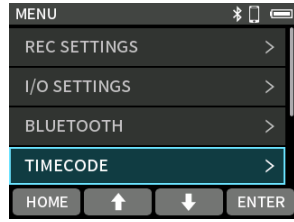
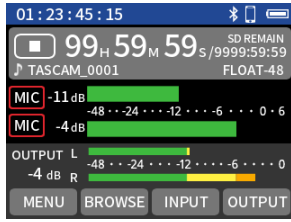

Press the F1 [MENU] button.

Select TIMECODE and press the F4 [ENTER] button.

15-1. Timecode selection

TC GEN MODE

TIMECODE screen

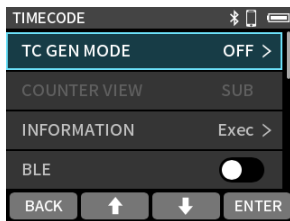

Select TC GEN MODE and press the F4 [ENTER] button.

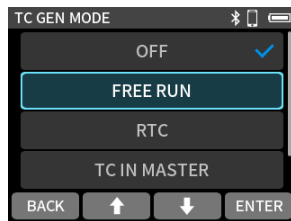

Select the setting to be used and press the F4 [ENTER] button.

OFF (default)

Do not use timecode
Timecode will not be shown on the HOME screen.

FREE RUN

Timecode is generated from the FREE RUN • START TIME setting and used as the master.

RTC

Timecode is generated from the time of the unit's built-in clock and used as the master.

TC IN MASTER

Timecode input through the EXT/TC In jack is used as the master.

BLE MASTER

Timecode input by Bluetooth is used as the master.

COUNTER VIEW

SUB (default) / MAIN

Unless TC GEN MODE is "OFF", the display positions of the counter and timecode on the HOME screen can be switched.

HOME screen when stopped

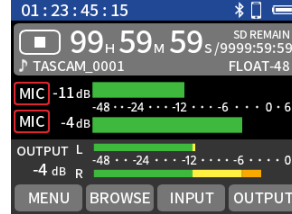

When COUNTER VIEW is set to SUB

HOME screen when stopped

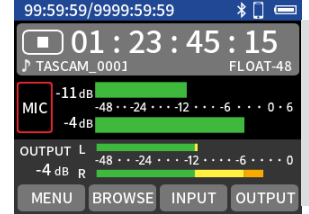

When COUNTER VIEW is set to MAIN

Receiving timecode by wire

TIMECODE screen

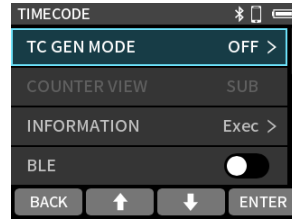

Select TC GEN MODE and press the F4 [ENTER] button.

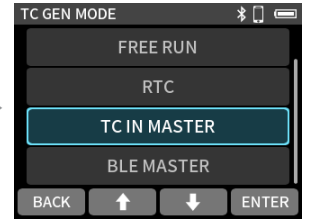

Select TC IN MASTER and press the F4 [ENTER] button.

- If "TC IN MASTER" is selected when INPUT screen > INPUT is set to "EXT", the L channel of the EXT input will be turned off and the input sound will become silent.
- For this unit to read timecode from the TC IN, input must be in the specified level range for LTC.
- When inputting audio through the EXT/TC IN jack, select a setting other than "TC IN MASTER".
- After receiving timecode, if "TC IN MASTER" is switched to "FREE RUN" or the cable connected to the EXT/TC IN jack is disconnected, the unit will run freely based on the timecode data that it received most recently.

Receiving timecode by Bluetooth

Set TC GEN MODE to "BLE MASTER" and TIMECODE > BLE to "ON". See "Wireless timecode synchronization with supported Atomos products" on page 55 for details.

15. Timecode functions

Outputting timecode

Set TC GEN MODE to anything other than "OFF" and set the following.

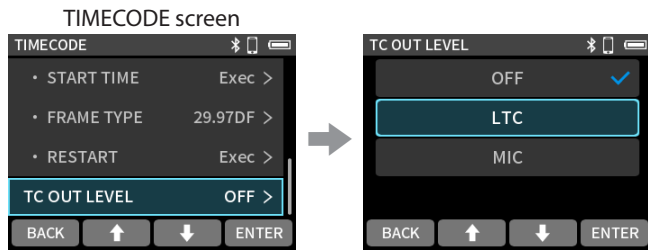

Select TC OUT LEVEL and press the F4 [ENTER] button.

Select "LTC" or "MIC" and press the F4 [ENTER] button.

OFF (default)

Audio will be output from the line output.

LTC

Select this to input the timecode output to another device that receives timecode. (1.8 Vpp)

MIC

Select this to input the timecode output to a camera. (50 mVpp)

- Select the output setting according to the input specifications of the device receiving the timecode.
- When outputting audio from the line output, set it to "OFF".
- When TC OUT LEVEL is set to LTC or MIC, LTC will be output from the line output.

In this case, "TC OUT" will be shown on the HOME screen.

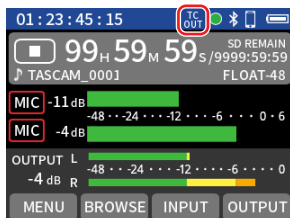

TIMECODE INFORMATION

This shows the timecode that is being received or sent.

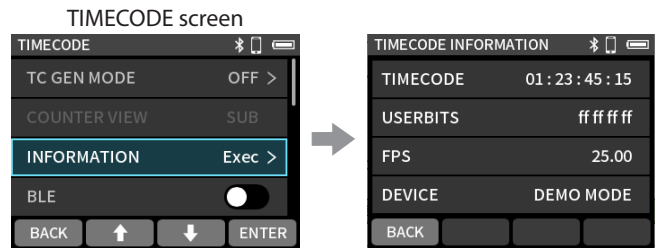

Select INFORMATION and press the F4 [ENTER] button.

After confirming, press the F1 [BACK] button.

TIMECODE

This shows the timecode as hours: minutes: seconds: frames.

USERBITS

This shows the user bits (date, time, scene number or other chosen data) set with the AtomX SYNC/UltraSync BLUE or other device.

FPS

This shows the frame rate.

DEVICE

This shows the name of the AtomX SYNC/UltraSync BLUE or other device.

FREE RUN

Set the behavior when TC GEN MODE is set to "FREE RUN".

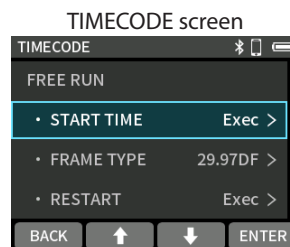

Select the item to set and press the F4 [ENTER] button.

START TIME

This sets the initial timecode value.

FRAME TYPE

This sets the FPS during free running operation. The default value is 29.97DF.

RESTART

This restarts timecode from the "START TIME" setting.

NOTE

If the unit power is turned off during free running operation and then turned on again, timecode will start with the initial value set by START TIME.

16. Wireless audio monitoring functions

16-1. Wireless audio monitoring

Monitoring sound from this unit can be output to earphones, speakers and other devices that support Bluetooth.

- Enable Bluetooth transmission on the earphone, speaker or other device that supports Bluetooth. Then conduct pairing and connection operations.
- The default value is "OFF".

HOME screen when stopped

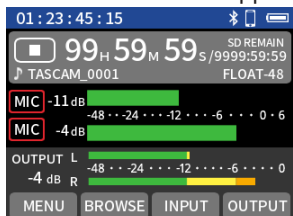

Press the F1 [MENU] button.

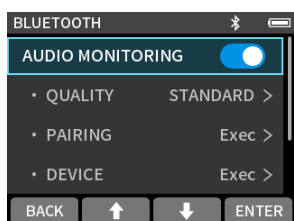

Set BLUETOOTH > AUDIO MONITORING to "ON".

NOTE

See "Slider switches" on page 22 for procedures to change settings.

Pairing

Pairing this unit with an earphone, speaker or other device that supports Bluetooth is necessary to connect this unit the first time or to connect with a different Bluetooth-compatible device for the first time.

BLUETOOTH screen

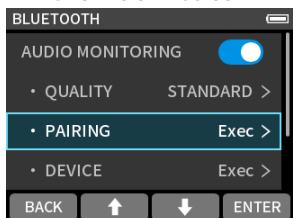

Select PAIRING and press the F4 [ENTER] button.

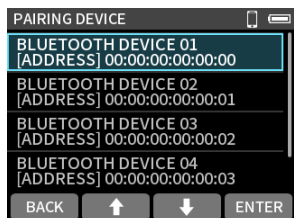

Select the device to connect and press the F4 [ENTER] button.



Press the F4 [YES] button.

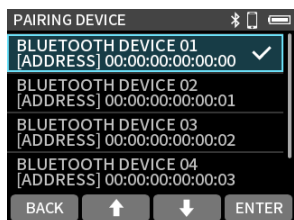

A check will appear next to the device name after connection completes.

After connection, the normal monitoring sound will be output. Use the OUTPUT > OUTPUT LEVEL setting or the (headphone) volume buttons to adjust the volume.

CAUTION

This display of this unit can only show half-width (normal) alphabet letters and numbers (single-byte). If a device name uses Japanese, Chinese or other full-width characters (double-byte characters), pairing is possible, but the name cannot be shown correctly.

NOTE

Up to 20 Bluetooth devices can be saved.

Connecting with already paired devices

BLUETOOTH screen

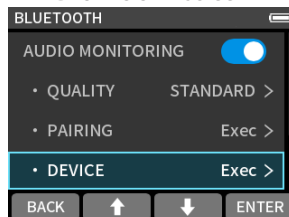

Select AUDIO MONITORING > DEVICE and press the F4 [ENTER] button.

Display example

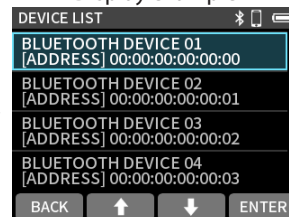

Select the device to connect and press the F4 [ENTER] button.

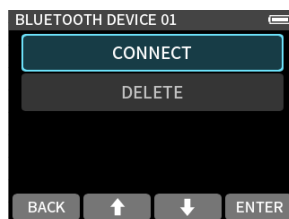

Select CONNECT and press the F4 [ENTER] button.



Press the F4 [YES] button.

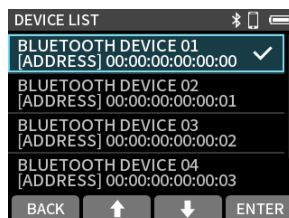

A check will appear next to the device name after connection completes.

16. Wireless audio monitoring functions

Deleting pairing data

This unit can save pairings with up to 20 Bluetooth devices. Delete this data to prevent automatic connection,

BLUETOOTH screen

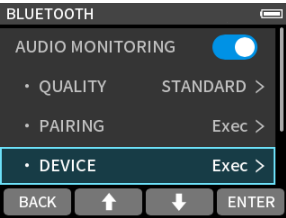

Select AUDIO MONITORING • DEVICE and press the F4 [ENTER] button.

Display example

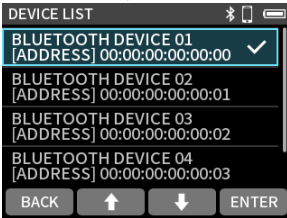

Select the device to delete and press the F4 [ENTER] button.

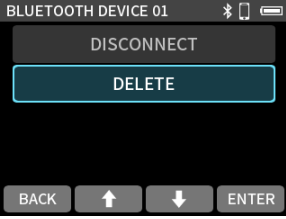

Select DELETED and press the F4 [ENTER] button.

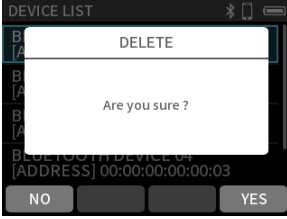

Press the F4 [YES] button.

Quality settings (QUALITY)

BLUETOOTH screen

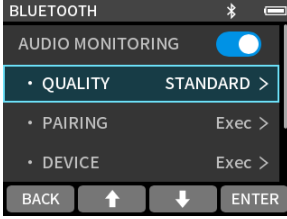

Select QUALITY and press the F4 [ENTER] button.

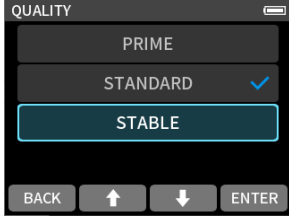

Select the quality and press the F4 [ENTER] button.

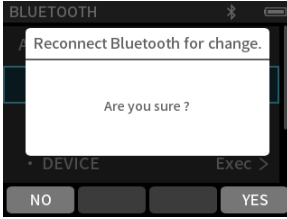

Connection will be interrupted after making the setting, so connect again.

Press the F4 [YES] button.

PRIME

This setting prioritizes quality. Connection stability could worsen depending on radio wave conditions.

STANDARD (default)

This setting balances audio quality and connection stability.

STABLE

This setting prioritizes connection stability. The audio quality will be worse compared to other settings because the transmission rate is lowered.

NOTE

The sound of wireless audio monitoring will be slightly delayed compared to the sound being recorded or played by the unit. The delay time could vary depending on the surrounding environment and radio wave conditions. The delay time is also affected by the QUALITY setting. The order from most to least is STABLE, STANDARD, PRIME.

17-1. Showing various information

Card information

MENU screen > SYSTEM > CARD INFORMATION

This shows information about the microSD card.

System information

MENU screen > SYSTEM > SYSTEM INFORMATION

This shows the firmware and hardware versions.

17-2. Resetting the date and time

Select and use the MENU screen > SYSTEM > DATE/TIME item. See "Set the date and time" on page 18 for operation procedures.

17-3. Resetting the unit to its factory defaults.

Select and use the MENU screen > SYSTEM > SYSTEM INITIALIZE item.

NOTE

This will also delete data added for AUDIO MONITORING. Conduct pairing again.

17-4. Formatting microSD cards

Select and use the MENU screen > SYSTEM > FORMAT SD item. See "Formatting (initializing) microSD cards" on page 19 for operation procedures.

17-5. Using the automatic power saving function

Set this using MENU screen > POWER/DISPLAY > AUTO POWER SAVE. When on, the unit automatically turns off after 30 minutes have elapsed since the last activity or operation.

OFF (default) / ON

NOTE

This function only works when the unit is stopped. This function will not cause the unit to turn off during recording or playback.

17-6. Selecting the power source

Set this using the MENU screen > POWER/DISPLAY > POWER SOURCE item.

BATTERY

Operate using battery power. Do not use USB power supply.

AUTO (default)

Use USB power supply when available.

CAUTION

When selecting BATTERY as the power source, always put batteries in this unit.

NOTE

When connecting this unit with an iOS device, set it to use batteries.

17-7. Setting the AA battery type (BATTERY)

Set this using MENU screen > POWER/DISPLAY > BATTERY.

Use this to set the type of battery used.

This setting is used to show the amount of remaining battery charge and determine if the unit has enough power for normal operation.

ALKALI (default)

Alkaline batteries

Ni-MH

Nickel-metal hydride batteries

LITHIUM

Lithium batteries

17-8. Saving and recalling user settings

Use MENU screen > OTHER SETTINGS > USER SETTINGS to do this.

All unit settings can be saved and recalled.

A maximum of 3 presets can be saved.

NOTE

- Before saving and when the system has been initialized, they will be set to their default values.
- The following three settings are not saved.

POWER SOURCE (BATTERY / AUTO)

BATTERY (ALKALI / Ni-MH / LITHIUM)

FILE NUMBER

17-9. Power saving (energy conservation) mode

Set this using the MENU screen > POWER/DISPLAY > POWER SAVE MODE item.

POWER SAVE MODE

When the power saving mode is on, the following six functions are limited to reduce power consumption.

- Only 48 kHz can be selected as the sampling frequency. 96 kHz and higher cannot be selected.
- Phantom power is turned off. Condenser mics with balanced connections to XLR jacks cannot be used.
- The backlight illumination time of the display is fixed at 30 seconds.
- The display brightness setting is fixed to MID.
- The PEAK LED indicators on the rear of the unit will not light.
- The CONTRAST of the display is fixed to 10.

BACKLIGHT

This sets the display backlight.

OFF: Backlight always off

5–30 sec: Backlight turns off automatically after set time without operation

ALWAYS: Backlight always stays on (default)

NOTE

The backlight setting is only active during battery operation. The backlight will always stay lit when operating on USB bus power.

BRIGHTNESS

This sets the display brightness.

The default value is "MID".

INDICATORS

This sets how the REC and PEAK indicators light.

ALL ON: Both REC and PEAK LEDs light. (default)

PEAK LED OFF: PEAK LEDs will not light.

REC LED OFF: REC LED will not light.

ALL OFF: REC and PEAK LEDs will not light.

NOTE

- When the POWER SAVE MODE setting is off, BACKLIGHT, BRIGHTNESS and INDICATORS settings can be made.
- If the POWER SAVE MODE is on when operating using battery power, the backlight will dim after 30 seconds without use. Pressing a button will cause the backlight to light, making operation possible.

17-10. Adjusting the display contrast (CONTRAST)

Set this using the MENU screen > POWER/DISPLAY > CONTRAST item.

The display contrast can be set between 0 and 20.

The default value is 10.

17-11. MENU

Category	Menu item	Settings	Reference
REC SETTINGS	REC FORMAT	48kHz (Default) / 96kHz / 192kHz	page 40
	BIT DEPTH	24bit/32-bit float (Default)	
	REC PAUSE MODE	OFF (Default) / ON	page 38
	PRE REC	OFF (Default) / ON	page 40
	REC HOLD	OFF / ON (Default)	page 38
I/O SETTINGS	PHANTOM VOLTAGE	+24V / +48V (Default)	page 33
	MS DECODE	OFF (Default) / REC/MONITOR	page 34
	- WIDE	0 / ... / 50 (Default) / ... / 100	page 34
BLUETOOTH	AUDIO MONITORING	OFF (Default) / ON	page 59
	- QUALITY	STABLE / STANDARD (Default) / PRIME	page 60
	- PAIRING	EXE	page 59
	- DEVICE	EXE	page 59
	REMOTE CONTROL	OFF (Default) / ON	page 54
	BLUETOOTH ID	AV2-xxxxxxx (x: Serial No.)	page 55
TIMECODE	TC GEN MODE	OFF (Default) / FREE RUN / RTC / TC IN MASTER / BLE MASTER	page 57
	COUNTER VIEW	SUB (Default) / MAIN	page 57
	INFORMATION	xx h xx m xx s xx f USER BITS : 00 00 00 00 FPS : 00.00 DEVICE: xxxxxx (BLE only)	page 58
	BLE	OFF (Default) / ON	page 57
	- CONNECT	EXE	page 55
	- FORGET	EXE	page 56
	FREE RUN	-	page 58
	- START TIME	EXE	
	- FRAME TYPE	23.98 / 24.00 / 25.00 / 29.97 / 29.97DF (Default) / 30.00/30.00DF	
	- RESTART	EXE	
	TC OUT LEVEL	OFF (Default) / LTC / MIC	page 58
SD CARD READER	EXE	-	page 52
OTHER SETTINGS	USER SETTINGS	-	page 61
	- SAVE	USER SETTINGS 1 / USER SETTINGS 2 / USER SETTINGS 3	
	- LOAD	USER SETTINGS 1 / USER SETTINGS 2 / USER SETTINGS 3	
	SLATE TONE	-	page 51
	- AUTO	OFF (Default) / HEAD / HEAD+TAIL	page 51
	- LEVEL	-12dB / -18dB (Default) / -24dB / -30dB / -36dB	page 51
	- OSCILLATOR	EXE	page 51
	MARK	-	page 50
	- MARK SKIP MODE	ALL (Default) / MANUAL / TIME / PEAK / BOF	page 50
	- TIME MARK	OFF (Default) / 5min / 10min / 15min / 30min / 60min	page 50
	- PEAK MARK	OFF (Default) / ON	page 50

17. Various settings

Category	Menu item	Settings	Reference	
SYSTEM	FILE NAME	TEXT / DATE (Default) / UNIT NAME	page 43	
	- TEXT	AV2-00000 (Default)	page 43	
	- NUMBER	EXE	page 44	
	DATE/TIME	EXE	page 18	
	UNIT NAME	This shows the value set in the app. If it has not been set, "--" will be shown.	page 43	
	CARD INFORMATION	CARD		page 61
		- TOTAL FILE		
		- TOTAL FOLDER		
		- TOTAL SIZE		
		- USED SIZE		
	FORMAT SD	QUICK FORMAT/FULL ERASE FORMAT	page 19	
SYSTEM INFORMATION	SYSTEM		page 61	
	- F/W VERSION			
	- H/W VERSION			
SYSTEM INITIALIZE	EXE	page 61		
POWER/DISPLAY	AUTO POWER SAVE	OFF (Default)/ON	page 61	
	POWER SOURCE	BATTERY / AUTO (Default)	page 61	
	BATTERY	ALKALI (Default) / Ni-MH / LITHIUM	page 61	
	POWER SAVE MODE	OFF (Default) / ON	page 62	
	- BACKLIGHT	OFF / 5sec / 10sec / 15sec / 30sec / ALWAYS (Default)		
	- BRIGHTNESS	LOW / MID (Default) / HIGH		
	- INDICATORS	ALL ON (Default) / PEAK LED OFF / REC LED OFF / ALL OFF		
	CONTRAST	0 / ... / 10 (Default) / ... / 20	page 62	

17-12. BROWSE

Menu item	Settings	Reference
FILE	-	page 48
- SELECT	-	page 48
- FILE DELETE	-	page 48
- RENAME	EXE	page 48
- CHANGE PROTECT	-	page 48
- FILE INFORMATION	FILE	page 48
	FORMAT	
	DATE	
	DURATION	
- MARK	EXE	page 49
FOLDER	-	page 46
- OPEN	-	
- RENAME	EXE	
- ALL FILES DELETE	-	
- FOLDER DELETE	-	

17-13. INPUT SETTINGS

Menu item	Settings	Reference
REC LEVEL	0dB (Default) / ... / +60.0dB (Step: 0.5dB)	page 30
GANG	OFF (Default) / ON	page 30
REC ENABLE	OFF / ON (Default)	page 31
INPUT	MIC (Default) / LINE / EXT / USB	page 31
	MIC (Default) / LINE / EXT (ST) / EXT (MONO) / USB	
STEREO LINK	OFF (Default) / ON	page 31
PHANTOM	OFF (Default) / ON	page 31
PLUG IN POWER	OFF (Default) / 2.5V / 5V	page 31
DELAY	0 (Default) / ... / 300ms	page 31
LOW CUT	OFF (Default) / 40Hz / 80Hz / 120Hz / 220Hz	page 31
DYNAMICS	OFF (Default) / LIMITER / COMP	page 31
EQ	OFF (Default) / INTERVIEW / MUSIC / MANUAL (EXE)	page 32
NOISE GATE	OFF (Default) / LOW / MID / HIGH	page 32
PHASE INVERT	OFF (Default) / ON	page 32
MS WIDE	0 / ... / 50 (Default) / ... / 100	page 34
PRESET SAVE	PRESET1 / PRESET2 / PRESET3	page 36
PRESET LOAD	PRESET1 / PRESET2 / PRESET3	page 37

MANUAL EQ

Menu item	Settings	Reference
LOW GAIN	-12 dB / ... / 0 dB (Default) / ... / +12 dB (Step: 1 dB)	page 32
LOW FREQ	32 Hz-1.6 kHz (Default: 400 Hz)	
L-MID GAIN	-12 dB / ... / 0 dB (Default) / ... / +12 dB (Step: 1 dB)	
L-MID FREQ	32 Hz-18.0 kHz (Default: 1.7 kHz)	
L-MID Q	0.25 / 0.5 / 1.00 / 2.00 (Default) / 4.00 / 8.00 / 16.00	
H-MID GAIN	-12 dB / ... / 0 dB (Default) / ... / +12 dB (Step: 1 dB)	
H-MID FREQ	32 Hz-18.0 kHz (Default: 1.7 kHz)	
H-MID Q	0.25/0.5/1.00/2.00(Default)/4.00/8.00/16.00	
HIGH GAIN	-12 dB/.../0 dB(Default)/.../ +12 dB (Step: 1 dB)	
HIGH FREQ	1.7 kHz-18.0 kHz (Default: 5.5 kHz)	

17-14. OUTPUT SETTINGS

Menu item	Settings	Reference
OUTPUT LEVEL		page 35
- L	-60.0dB / ... / 0.0dB (Default) (Step: 0.5dB)	
- R	-60.0dB / ... / 0.0dB (Default) (Step: 0.5dB)	
GANG	OFF / ON (Default)	page 35
OUTPUT	MONO (Default) / STEREO	page 35
- LINE OUT	LINE (Default) / CAMERA	page 51
- SOLO	OFF (Default) / CH 1 / CH 2	page 40
MS WIDE	0 / ... / 50 (Default) / ... / 100	page 35
LIMITER	OFF (Default) / ON	page 35
DELAY	0 (Default) / ... / 300ms	page 35

18. Messages

The following is a list of the pop-up messages.

Refer to this list if one of these pop-up messages appears on the FR-AV2 and you want to check the meaning or determine a proper response.

Message	Details and response
No Card	Load a microSD card.
Card Error	The microSD card could not be recognized. Change the microSD card.
Card Full	The microSD card has no remaining capacity.
Format Error Format Card	The microSD card might not be formatted properly, or it might be broken. Tap the screen to start formatting. Formatting will erase all data on the microSD card.
Invalid Card Change Card	Something might be wrong with the microSD card. Change the microSD card.
MBR ERROR Init CARD	The microSD card might not be formatted properly, or it might be broken. Tap the screen to start formatting. Formatting will erase all data on the microSD card. If formatting is not possible, change the microSD card.
Write error Recording will continue	Writing to the microSD card timed out. This has caused audio to be interrupted and noise to occur. A BOF mark was added at the point when audio was interrupted.
Card slow Check BOF mark	microSD card writing performance has become worse. A BOF mark has been added at the point when audio was interrupted because writing to the microSD card timed out. Check the audio around the BOF mark. Execute the erase format function or change the microSD card.
Invalid SysFile Make Sys File	The system file required to operate this unit is invalid. Tap the screen to create a system file.
Non- Supported	See the Reference Manual for file formats that this unit can use. ("Recording/playback formats" on page 69)
File Num Full	Recording is not possible because the total number of folders and files would exceed the limit of 1000.
File Not Found	The file was not found or might be damaged. Check the relevant file.
Cannot delete because file protected	Remove protection from a file before trying to delete it.

Message	Details and response
Can't delete Not empty	Folders that contain files cannot be deleted. Delete all the files in the folder and try again.
Adding marks not possible because file protected	Marks cannot be added because the file is protected from writing. Remove protection from a file to add marks to it.
Can't MARK File length	Marks cannot be added because the file is too short.
File error	If any of these errors occur, turn the unit off and restart it. If the unit cannot be turned off, remove the batteries, and disconnect the AC adapter (TASCAM PS-P520U, sold separately).
Error occurred	
Playback Error	
Writing Failed	
System error AA (AA is a number)	If these error messages continue to appear frequently, please contact a TEAC Repair Center.
USB FS Mismatch	The sampling frequency settings of this unit and the USB computer audio interface are not the same. Change the setting of one so that they are the same.
Battery is overheated. Change to USB power supply.	The internal temperature has become higher when using AA batteries. You can continue to use the unit by powering it with a USB connection.
Device is overheated. Turn off the power.	The internal temperature has become higher. The system will shut down automatically.
No track selected	No recording track has been selected. Turn input on for tracks to be recorded on the Input Screen. ("Setting channels to record (REC ENABLE)" on page 31)

If you are having trouble with the operation of this unit, please check the following before seeking repair. If these measures do not solve the problem, please contact the store where you bought the unit or TASCAM customer support service.

Power will not turn on

- Confirm that batteries are installed correctly.
- Confirm that the TASCAM PS-P520U AC adapter (sold separately) power plug and the USB connector are securely connected. The unit might not operate properly through a USB hub.

The unit turns off automatically

- Confirm that the automatic power saving function is disabled.
 - The automatic power saving function can be turned on/off using the MENU screen > POWER/DISPLAY > AUTO POWER SAVE item.
("Using the automatic power saving function" on page 61)

Operation is not possible using the unit controls

- Unit operations are not possible when "SD CARD READER" appears on the screen.

The microSD card is not recognized.

- Confirm that the microSD card is inserted completely.
- Format it with a computer, and reinsert it.

No sound is output

- Check the unit's headphone output level.
- Check the monitoring system connections and volume level.

Recording is not possible

- Confirm that the microSD card has enough open space.
- Recording becomes impossible when the total number of files reaches 1000.

The input sound is extremely quiet or loud

- Check the recording level setting. ("Adjusting the recording level (REC LEVEL)" on page 30)
- Check the output levels of connected external equipment.

A file cannot be erased

- A protected (read only) file cannot be erased.

This unit's files do not appear on the computer.

- Confirm that the unit is properly connected to the computer using its USB port. The unit might not operate properly if connected through a USB hub.
- To show the unit's files on a computer, after connecting the unit to the computer using a USB cable, operation from the MENU screen is necessary. ("Accessing microSD cards from a computer" on page 52)

Noise is occurring

- If this unit is near a mobile phone, TV, radio, power amplifier or other device with a large transformer, noise could occur with this unit or other devices nearby.

Headphone volume is low

- Press the + Ω (headphone) volume button. ("Adjusting the headphone output volume" on page 27)

The date/time is incorrect

- This can be set again using the MENU screen > SYSTEM > DATE/TIME item. ("Set the date and time" on page 18)

MENU screen cannot be opened

- The MENU screen cannot be opened when the unit is recording, in recording standby, playing back or paused. Press the ■/HOME button to stop the unit. Then, press the F1 [MENU] button.

A file is not recognized

- Recognizing files correctly becomes impossible when the total number of files exceeds 1000.
- Subfolders below the third level cannot be shown.
- This unit cannot show files that are not in the SOUND folder. ("File and project structure overview" on page 44)
- Only wav files, including in BWF format, will be shown.
- Files that are damaged cannot be shown correctly by this unit.

Batteries run out of power quickly

Try the following.

- Reduce the backlight time.
("Power saving (energy conservation) mode" on page 62)
- Turn off all indicators.
("Power saving (energy conservation) mode" on page 62)
- Reduce the brightness.
("Power saving (energy conservation) mode" on page 62)
- Reduce the contrast.
("Power saving (energy conservation) mode" on page 62)
- Turn the recording pause function on.
("Overview of recording" on page 38)
- Lower the headphone volume.
- Disconnect input and output devices that are not in use.

The screen is dim

- Set the backlight to stay lit always.
("Power saving (energy conservation) mode" on page 62)

NOTE

The screen will always be dim if the MENU screen > POWER/DISPLAY • BACKLIGHT setting is "OFF".

Volume is low when monitoring audio by Bluetooth (when using an AK-BT2)

- The volume of the Bluetooth headphones or speakers might be lowered. Try operating them to raise the volume.
- Press the + Ω (headphone) volume button. ("Adjusting the headphone output volume" on page 27)

Cannot connect to a Bluetooth device for audio monitoring (when using an AK-BT2)

- Confirm that the Bluetooth device is in a state that allows connection.
- Pairing might not be possible if the device and this unit are far apart. Try moving this unit and the other Bluetooth device closer together.
- Confirm that the pairing data has not disappeared.
If it has disappeared, try pairing again.
- Depending on the status of the Bluetooth device, connection with this unit might not be possible.
Turn on the power of the Bluetooth device and reconnect it.
If it does not reconnect, conduct the connection procedures on this unit.

20-1. Specifications and rated values

Recorder specifications

Recording media

- microSD cards (64 MB – 2 GB)
- microSDHC cards (4 GB – 32 GB)
- microSDXC cards (48 GB – 512 GB)

Recording/playback formats

WAV (BWF): 48/96/192 kHz, 24-bit/32-bit float

Number of channels

Number of recording/playback tracks
2 tracks maximum

Analog audio input ratings

Mic/line inputs jacks 1–2 (balanced)

Connectors: XLR/TRS combo jacks

XLR3-31 equivalent (1: GND, 2: HOT, 3: COLD)

- Supports phantom power only when MIC input selected
- 6.3 mm standard TRS jacks (balanced)
(Tip: HOT, Ring: COLD, Sleeve: GND)

- TRS jacks do not support phantom power

When MIC input selected

Maximum input level: +4 dBu
Minimum input level: –76 dBu
Input impedance: 2.0 kΩ or more
Phantom power: +24 V / +48 V (selectable when MIC input selected)

When LINE input selected

Maximum input level: +24 dBu
Nominal input level: +4 dBu (GAIN setting at minimum)
Input impedance: 8 kΩ or more

Line input (unbalanced): /EXT/TC IN jack (can provide plug-in power)

Connector: 3.5 mm (1/8") stereo mini jack

/EXT (Tip: L ch, Ring: R ch, Sleeve: GND)

Maximum input level: 1 dBV
Nominal input level: –19 dBV (GAIN setting at minimum)
Minimum input level: –79 dBV
Input impedance: 6 kΩ or higher (when plug-in power is off)
1.6 kΩ or higher (when plug-in power is on)

Plug-in power: +2.5 V / +5.0 V

TC IN (Tip: Timecode IN, Ring: –, Shield: GND)

Input impedance: 10 kΩ or more
Input level: 0.5 Vp-p – 5.0 Vp-p

Analog audio output ratings

Line output (unbalanced): /LINE/TC OUT jack

Connector: 3.5 mm (1/8") stereo mini jack

/LINE (Tip: L ch, Ring: R ch, Sleeve: GND)

Output impedance: 210 Ω

Nominal output level: –10 dBV (with –16 dBFS as standard)

Maximum output level: +6 dBV

TC OUT

LTC selected

(Tip: Timecode OUT, Ring: –, Shield: GND)

Output impedance: 1.0 kΩ

Output level: 1.8 Vpp

When MIC selected

(Tip: Timecode OUT, Ring: R ch, Shield: GND)

Output impedance: 110 Ω

Output level: 50 mVpp

- 0 dBu = 0.775 Vrms

- 0 dBV = 1 Vrms

Headphone output: headphone jack

Connector: 3.5 mm (1/8") stereo mini jack

Maximum output: 50 mW + 50 mW (THD+N 0.1% or less, into 32 Ω load)

Working impedance: 16–400 Ω

USB

Port: USB Type-C

Transfer rate: USB 2.0 High Speed

Device classes: mass storage, USB audio 2.0 (USB class compliant)

USB Audio

Sampling frequency

48/96 kHz

Quantization bit depth: 24-bit/32-bit float

Number of input channels: 2 (output from unit)

Number of output channels: 2 (input to unit)

Timecode input/output

Format: SMPTE ST 12-1 compliant

Frame rates:

23.98, 24, 25 (50), 29.97 (59.94), 29.97DF (59.94DF), 30 (60) fps*

* For video with frame rates of 50 fps and higher, timecode of half the frame rate is used.

Bluetooth device connector

For Bluetooth adapter (AK-BT2) only

20. Specifications

Audio performance

Mic amp EIN (equivalent input noise)

–127 dBu or lower

Frequency response

Input jacks 1/2 to PCM data

When 48 kHz: 20–20 kHz: +0 dB/–0.5 dB

When 96 kHz: 20–40 kHz: +0.5 dB/–1.0 dB

When 192 kHz: 20–60 kHz: +0.5 dB/–3.0 dB

Dynamic range

Input jacks 1–2 to PCM data (20 kHz LPF, A-weighted, JEITA)

132 dB or higher

Total harmonic distortion ratio (THD+N)

Input jacks 1–2 (LINE/MIC IN) to PCM data (1 kHz sine wave

–2 dBFS input, minimum recording level setting, 20 kHz LPF,

JEITA)

0.02% or less

Note: JEITA indicates conformance to JEITA CP-2150

Recording times (in hours: minutes)

File format (recording setting)		Card capacity	
		32 GB (microSDHC)	128 GB (microSDXC)
WAV 24-bit (stereo linking on)	48 kHz	30:50	123:26
WAV 24-bit (stereo linking on)	96 kHz	15:25	61:43
WAV 24-bit (stereo linking on)	192 kHz	7:42	30:51
WAV 32-bit float (stereo linking on)	48 kHz	23:8	92:32
WAV 32-bit float (stereo linking on)	96 kHz	11:34	46:16
WAV 32-bit float (stereo linking on)	192 kHz	5:47	23:8

- The recording times shown above are estimates. They might differ depending on the microSD card in use.
- The recording times shown above are not continuous recording times, but rather they are the total possible recording times for the microSD card.
- When stereo linking is off and recording only 1 channel, the above recording times will be about twice as long.

Operating system and other requirements

Check the TASCAM website for the latest information about supported operating systems.

<https://teac-global.com/>

CAUTION

Operation with each OS was confirmed with standard system setups that met the following conditions.

Operation is not guaranteed, however, with all systems that meet the following conditions.

FR-AV2

Windows

Supported operating systems

Windows 11

Windows 10 64-bit

Computer hardware requirements

Windows computer with a USB 2.0 (or higher)

- Operation is not guaranteed using the TASCAM driver with ARM64 CPUs.

Mac

Supported operating systems

macOS 14 Sonoma

macOS 13 Ventura

Computer hardware requirements

Mac with USB 2.0 (or higher)

iOS/iPadOS devices

iOS 17/iPadOS 17

iOS 16/iPadOS 16

TASCAM RECORDER CONNECT

iOS / iPadOS devices

iOS 17/iPadOS 17

iOS 16/iPadOS 16

Android devices

Android 14

Android 13

Android 12

- Compatibility has been confirmed, but this does not guarantee operation with all devices.

Other

Power

- 3 AA batteries (alkaline, Ni-MH or lithium-ion)
- USB bus power from a computer
- AC adapter (TASCAM PS-P520U, sold separately)

Power consumption

3.8 W (maximum)

Battery operation time (continuous operation)

- Using alkaline batteries (EVOLTA)

Use conditions	Operation time
Input through input jacks 1–2 Phantom power unused 48 kHz stereo WAV (BWF) 24-bit recording	About 9 hours
Input through input jacks 1–2 Phantom power used (+48 V, 3 mA×2 load) 48 kHz stereo WAV (BWF) 32-bit float recording	About 4:30

- Using Ni-MH batteries (eneloop)

Use conditions	Operation time
Input through input jacks 1–2 Phantom power unused 48 kHz stereo WAV (BWF) 24-bit recording	About 8:30
Input through input jacks 1–2 Phantom power used (+48 V, 3 mA×2 load) 48 kHz stereo WAV (BWF) 32-bit float recording	About 5:30

- Using lithium-ion batteries (Energizer Ultimate Lithium)

Use conditions	Operation time
Input through input jacks 1–2 Phantom power unused 48 kHz stereo WAV (BWF) 24-bit recording	About 15 hours
Input through input jacks 1–2 Phantom power used (+48 V, 3 mA×2 load) 48 kHz stereo WAV (BWF) 32-bit float recording	About 10 hours

NOTE

When using phantom power, the operation time might be reduced depending on the mics being used.

Dimensions

99 × 80.4 × 40.3 mm (W x H x D, including protrusions)

Weight

267/195 g (with/without batteries)

Operating temperature range

0–40°C

- Illustrations in this manual might differ in part from the actual product.
- Specifications and external appearance might be changed without notification to improve the product.

20-2. Dimensional drawings

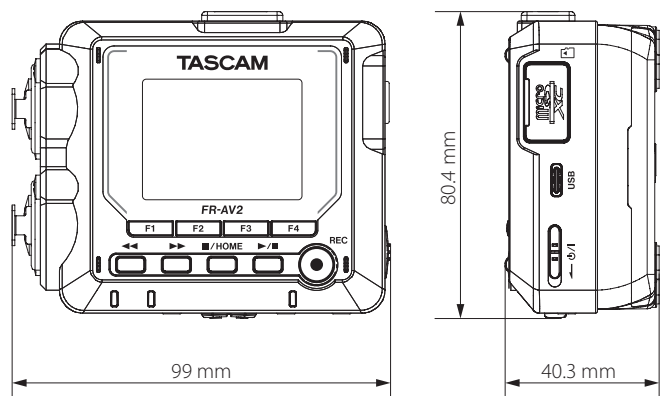

TASCAM

TEAC CORPORATION
Phone: +81-42-356-9143
1-47 Ochiai, Tama-shi, Tokyo 206-8530 Japan

<https://tascam.jp/jp/>

TEAC AMERICA, INC.
Phone: +1-323-726-0303
10410 Pioneer Blvd., Unit #3, Santa Fe Springs, CA 90670, U.S.A

<https://tascam.com/us/>

TEAC UK Ltd.
Phone: +44-1923-797205
Luminous House, 300 South Row, Milton Keynes, Buckinghamshire, MK9 2FR, UK

<https://www.tascam.eu/en/>

TEAC EUROPE GmbH
Phone: +49-611-71580
Bahnstrasse 12, 65205 Wiesbaden-Erbenheim, Germany

<https://www.tascam.eu/de/>

TEAC SALES & TRADING(SHENZHEN) CO., LTD
Phone: +86-755-88311561-2
Room 817, Xinian Center A, Tairan Nine Road West, Shennan Road, Futian District, Shenzhen, Guangdong Province 518040, China

<https://tascam.cn/cn/>

0824.MA-3926A